

GEDORE

ENTIRE RANGE



1819



Putting one's whole heart into it.

GEDORE red stands for high-grade professional tools achieved from concentration on essentials and intelligent solutions.

As the GEDORE brand product line, we place the maximum possible demands on our work. The extensive GEDORE red range goes down well thanks to its functionality, convenience-in-use and longevity. The stringent product standards underpinned by GEDORE's quality undertaking provide that common element running through our entire range of tools.

Backed by experience going back almost 100 years as well as skill, passion and customer proximity, we devise tools of high serviceability for safe, precision-like working.

We understand the world of tools, remain authentic and put our hearts into the work.

Whether on a personal level or in business, we always speak our customers' language. Intelligent solutions that we devise are there to assist you in your projects.

Our perfected products and constant striving for improvement illustrate just how we live and love our trade down to the last detail. This makes GEDORE the partner for you in the matter of highly efficient and dependable tools.



› 124
TORQUE WRENCHES



› 090
SOCKET SETS



› 172
1000 V



› 052
RATCHET SPANNERS



› 028
WORKSHOP
EQUIPMENT

TOOL HERO STORIES

> 006



TOOL ASSORTMENTS

014 - 023



MOBILE TOOL STORAGE

024 - 027



WORKSHOP EQUIPMENT

028 - 037



TOOL MODULES

038 - 051



RATCHET SPANNERS

052 - 065



RANGE OF SOCKETS

066 - 089



SOCKET SETS

090 - 123



TORQUE WRENCHES

124 - 125



SCREWDRIVERS AND BITS

126 - 137



PLIERS

138 - 145



VICES

146 - 147



STRIKING TOOLS

148 - 157



MEASURING / MARKING

158 - 161



CUTTING / FILING / DRILLING

162 - 171



1000 V

172 - 177



AUTOMOTIVE

178 - 189



> 024
MOBILE TOOL STORAGE



> 146
VICES

1



TOOL HERO STORY

FEEL THE POWER OF THE ENGINE DIRECTLY

It all began with a Yamaha R6. It was Flo's first motor bike. Since then over a 12-year time span he has turned his passion into gainful employment and is now the proud owner of an entire shop full of bikes.



2



3

4



1. It keeps to its promise: the practical R19102000 magnetic tray, 2. Flo working on a Ducati 899 Panigale. 3. Easy tyre changing with a R68900200 torque wrench. 4. Close-up shot of the R68003026 screwdriver bit socket set. 5. Flo with his transformer made of used scooter and car parts.



In his FLO RIDER MOTOLOFT in Solingen, Florian Schmand - aka Flo - services, repairs and brokers new and used bikes of all the usual makes and brands.

Even at school, Flos' interest was very much on two-wheelers. He bought himself a moped when 15. Two years later he switched to a 125 scooter. Flo got his motor bike license and his first Yamaha R6 when he was 18.

He decided to set up his own business during the automobile crisis in 2019. "As I couldn't get a bank loan, I began to build up a small business on the side when I was an industrial fitter", he said, looking back. In his garage in front of the house, Flo got his first bikes into shape and sold them online. Business went better than expected. "I was forced to rent a larger garage but I still could not manage all the work", Flo continued. He then decided to give up his job and in 2013 fulfilled his dream of owning his own shop. His modern MOTOLOFT covers two storeys including showroom, gallery and workshop. What really catch the eye are Flo's huge transformers made of used scooter and car parts. He always inspects his machines visually and from the technical angle before they are sold. "I'm very finicky there". I have never forgotten my mum's saying »A tidy house, a tidy mind«, says Flo with a grin. This is something immediately evident in his work-

shop. Well-sorted, GEDORE red tools such as screwdrivers, pliers and spanners hang from his perforated board above the workbench. Flo's favourite: the GEDORE red WINGMAN. "To be truthful, the one thing you really need in a workshop is a well stocked tool trolley. If everything is well arranged, you'll find what you're looking for that much quicker.

Although he does not keep his bikes very long, his favourite is Ducati and particularly the Ducati Panigale. It is not only the technical and design combination that make the machine so unique for him. "It's an indescribable feeling to feel the power of the engine so directly", Flo enthusiastically explains. A reason, in fact, as to why he himself wants to have this machine in 2018. "Unfortunately I have hardly had any time over the past two years to ride the machine. That is what I intend to change this year".



1. The R09100280 combination spanner ensures that every screw is firmly tight. 2. Tool set T-handle R49005037 plus ratchet tool for an optimum power transfer. 3. 9-piece R36675000 hexagon socket key set with ball end. 4. Sanna and Hannes working outdoors. 5. Happy Family: Hannes, Sanna and Labrador bitch Fini.



READY, JET, GO!

Work where others go on holiday – this is the dream that Sanna and Hannes have fulfilled. Their wakeboard school - KAHAWAI Watersports - with jet ski hire and wake shop is sited on a peninsula near Roermond – just 10 minutes by car on the other side of the Dutch border.

Their school is in the Marina Oolderhuske recreational park and has its own mooring point which also serves as a place for repairs /servicing. From here, German guests in the main start their water sports adventure.

This year Sanna gave up her teaching job and together with Labrador Fini moved away from Bergisch Gladbach to set up a new life with Hannes 100 kms to the west. Both Sanna and Hannes are German born and grew up separately with water sports. It was a passion that brought them together. "At the time I was here with friends for wake boarding and Hannes was the coach. The spark between us ignited straight away", she recalls. Three years later and after a lot of here-and-there came the wedding and Sanna's decision to change the junior school for a wake school. Since April - and together with Hannes - she has been instructing wakeboarding at the boat and 2-mast installation, wakesurfing (like wakeboarding but without the line) and waterskiing.

Also on offer: tubing, banana boat, jet-ski and speed boat runs – fun sports booked, in particular, for company events and stag nights. "The funniest tales come about here. Just recently one of the bachelors was pulled along naked on his wakeboard", Sanna relates and laughs. Along



with hiring out equipment and organizing events, both of them service and maintain boat and jet ski – something done best of all outdoors. Whether it is a matter of removing the oil filter - needs to be done every 100 operating hours - or repairs to the boat propeller due to contact with the lake bed, "we need to have full confidence in our tools" emphasizes Hannes. His best-loved one is the GEDORE red ratchet box. "Just right as far as the weight goes and pleasant to handle", is his enthusiastic response.

Hannes looks upon screw/bolting work done under pressure i.e. between client appointments - as an effective means to an end. He feels quite differently about his favourite hobby i.e. pottering around on his mountain bike and quad. "That's where I can really unwind", he states. On clocking off, he likes driving off with Sanna and Fini and to taking turns in being pulled along by the boat.

His plans include opening a wake park with some 20 obstacles, a private beach, floating event hall and restaurant in De Weerd which borders their site.

TOOL HERO STORY

BUT ONLY WITH A STAR, PLEASE

Bartosch aka Toschi is married, a father and a passionate care dealer. His dressing style: pleasantly "subdued" - chino trousers, TC-shirt, jumper and sneakers.



The first thing that meets your eye on going into the Bartosch Markowski hall are the lined-up "stars" - of today's and yesterday's cars. Slightly hidden at the back are a hydraulic platform, tools and the GEDORE red MECHANIC workshop trolley.

In his Solingen »Fahrkultur« car dealership just 3 min. away from Tine, his wife, daughter Leni and Labrador Emma, Toschi sells one-year old cars, fairly new used cars as well as classic and vintage models – preferably sporting that star, of course. His passion for Mercedes Benz came about as a 19 year-old when training at Daimler. He worked for 10 years in the most varied of fields – from the spare parts store through to actual car sales. He repaired dated Vespas in his free time. "In selling Vespas I got to know a lot of great people. However, I made no money from the business", relates Toschi.

Since then six summers have gone by and a lot has happened. Toschi has fulfilled his dream of his own business and one with over 400m² of floor space. "I've enough room here to both present the gems I have and to pursue my favourite hobby", he says. What he means here is doing tool maintenance work on his vintage cars - and particularly on his red Bordeaux Mercedes on which he preferably uses his GEDORE red tools. Whether it is a matter of changing oil,

tyres and brake pads or replacing spark plugs – the GEDORE red ratchets, torque wrenches and the impact socket set are always at hand. "For me working with tools is a pleasant contrast to the daily sales talks and recalls my time at Daimler", continues Toschi.

Talking of Daimler: he loves to recount the story of his first convertible - an SLK - which he bought with his savings during his training time. "I was determined to get the car. This meant me having to drive over 700 kms right down into Bavaria", Toschi recalls. He had everything with him - number plates and the money. Unfortunately he could not hide his instant love for the car from the car dealer and had to pay the full price as displayed.

"A beginner's mistake! Would not happen to me today", says he with a grin.



2



3



4



5

1. Bartosch aka. Toschi is a passionate car dealer.
2. What Toschi is wild about: his Vespa and the R20400006 MECHANIC workshop trolley. 3. The lined-up cars all sporting "stars" of today's and yesterday's models. 4. For Toschi any tool work done is a pleasant escape from the sales talks. 5. The 100-piece 1/2"-1/4" combined socket set R46003100 is full to the brim with useful aids. 6. You've always got just what you need with the R38002012 screwdriver set.



6

1. Straight tipped telephone pliers R28512200 for flat and round material. 2. The 1/4" R40000027 reversible ratchet proves that small tools can do great things. 3. The R38910000 ratchet screwdriver being used on the steering wheel. 4. Aram and his quad – made from a Kawasaki Z1000. 5. The names of his two children adorn Aram's lower arm.

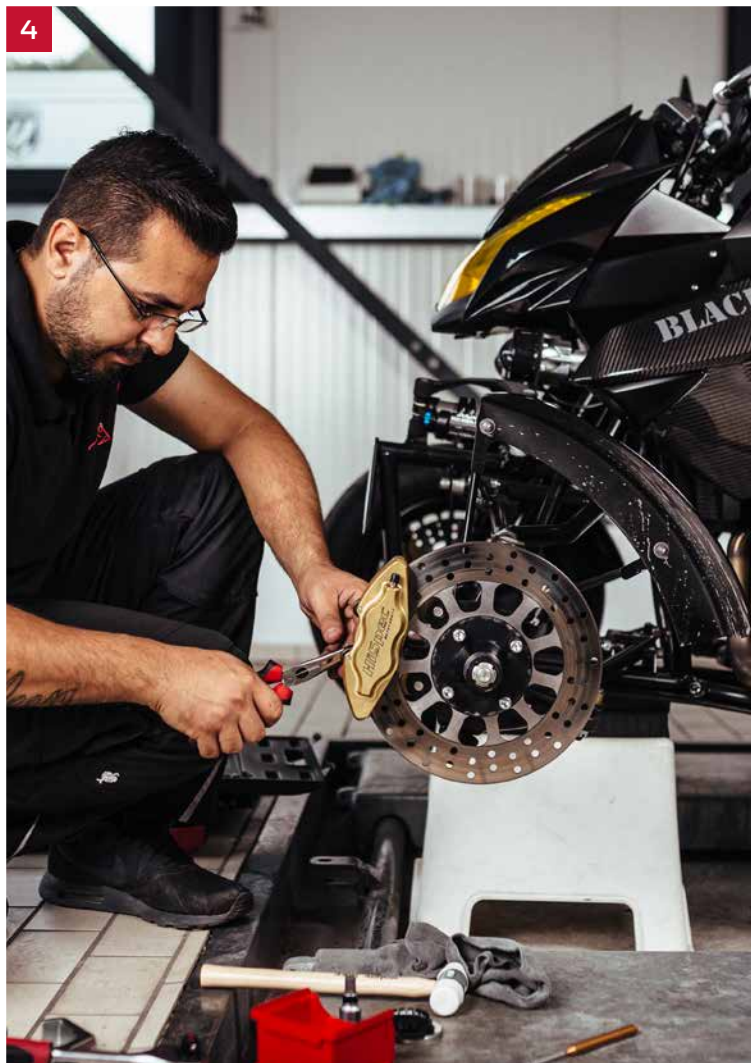

TOOL HERO STORY

LOWER, WIDER, FASTER!

When Aram pulls up in his black-and-white check-patterned Audi R8, you can't help but stare. Written in curved letters, clearly visible on the car: "Drive and Style", which is the name of his tuning workshop in Dortmund.



The qualified bodywork specialist has fulfilled his dream of his own workshop, office and pizzeria on this 25,000 m² site.

Born in Iran, Aram came to Germany as a refugee at the age of 4. He is also strongly drawn to the USA, where his father emigrated in 1994. He met his wife Jessica in 1998, while he was still training. When their daughter Aileen was born in 2006 they decided to settle in Dortmund. Two years later, Aram decided to set up his own business: the birth, in fact, of "Drive and Style". After starting out in a small hall, Aram opened his current workshop in 2014.

"Drive and Style" specialises in tuning top-end cars. Performance upgrades, changes in appearance using body kits, lowering, exhaust systems, rims, special painting, foliage and sound tuning are especially popular. "Lower, wider, faster – that never loses its appeal and Aram knows that. His wide-range GEDORE red assortment – clearly stored in the MECHANIC workshop trolley – ensures that all work proceeds smoothly. The GEDORE red ratchet box is what is most often used. "I use it to fit everything in the car and especially for the engine", continues Aram. His best-loved tool is the GEDORE red combination ratchet spanner. Once set up, you can easily work through everything with it", he comments enthusiastically.

Tuning trends come and go. Aram has happy memories of his VW Golf IV with wing doors: "That was twelve years ago – I was as proud as Punch. Today I would not dare to be seen in it on the roads", he recounts and laughs. His baby: a quad, made in co-operation with the EXEET company from a Kawasaki Z1000 – the Black Bull Drive and Style Edition. "I have always dreamt of driving something that no-one else has", he says with pride. And the result is something very special indeed: 150 hp, 220 km/h, the quarter of a mile (402 m) in 10.76 sec.

And his hard work pays off: today, he numbers footballers such as Marco Reus, Roman Neustädter and Julian Draxler among his clients. And one day, when money is no longer important, he'd like to launch his own vehicle on the market: "an Audi R8 and Lamborghini mix would be my dream."

TOOL ASSORTMENTS

014 - 023

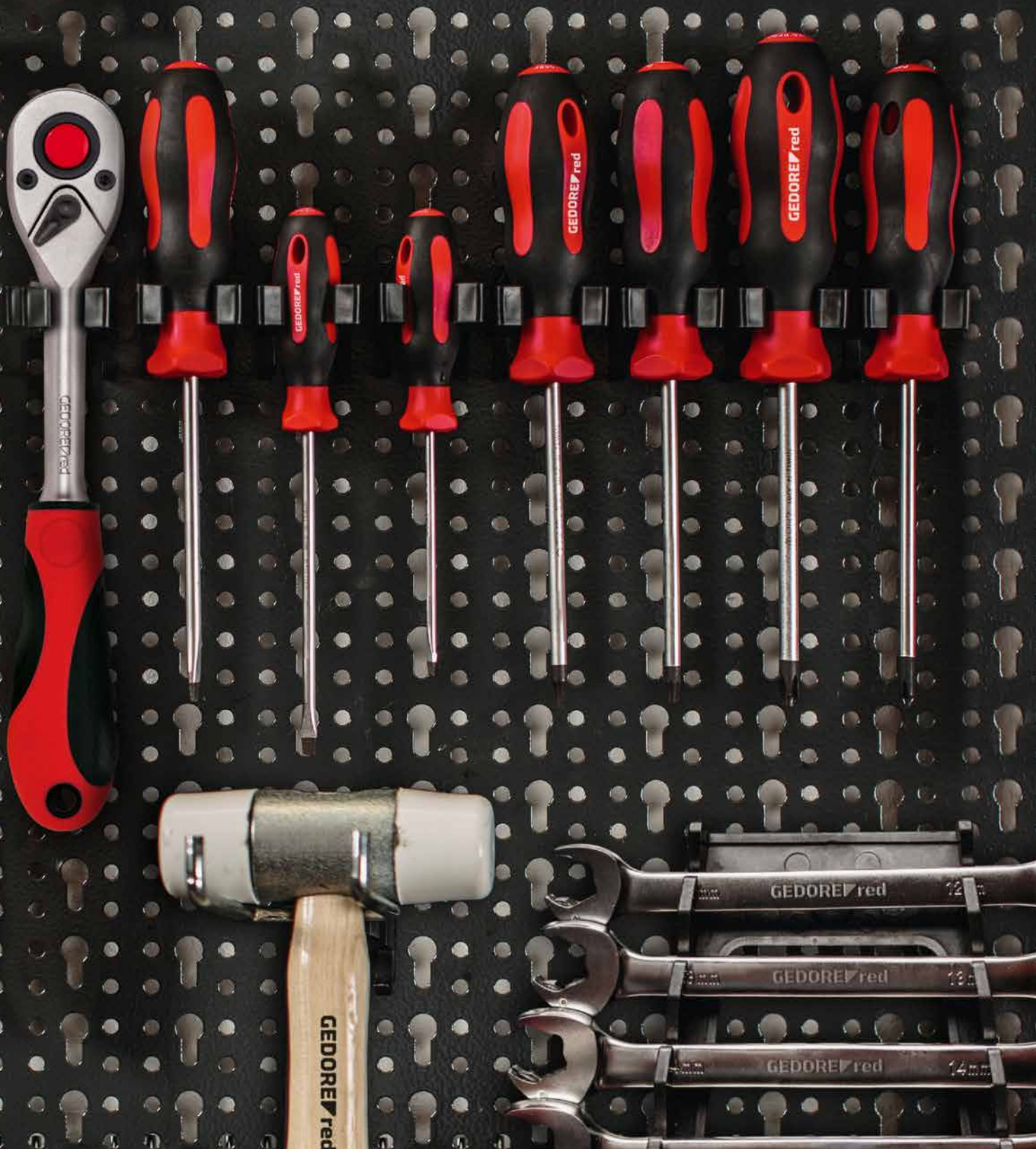

R2100072

UNIVERSAL SET BASIC

72 pieces

- > **Multifunction saw:** Rotating saw blade and frame, hand protector, dual-material handle, delivered with HSS bi-metal saw blade (24 tpi)
- > **Spirit level:** Smooth aluminium rectangular profile, two acrylic vials, measurement accuracy: +/- 0.5 mm/m, powder-coated, impact-resistant end cap
- > **Double open-ended spanner:** To DIN 3110, ISO 3318, ISO 1085, ISO 10102, 15° jaw position, surface matt satin plate-chromed, chrome-vanadium steel
- > **Engineers' hammer:** Forged hammer head of tempered steel, inductively hardened striking surfaces, to DIN 1041, ash handle, paint-coated shaft end, ring wedge
- > **Combination pliers:** To DIN ISO 5746, gripping zones for flat and round material, inductively hardened cutting edges, dual-material handle, chrome-vanadium steel
- > **Power side cutter:** To DIN ISO 5749, high degree of cutting performance, inductively hardened, long cutting edges, dual-material handle, chrome-vanadium steel
- > **Pincer:** To DIN ISO 9243, head ground, inductively hardened cutting edges, dipped handle covers, forged
- > **Tape measure:** ABS dual-material housing, clip, nylon-coated tape, mm-graduation, with tape rewind and lock, magnetic stop, Accuracy Class II
- > **Blue pencil:** Oval form
- > **2C screwdriver:** PZ slot and cross-slotted, acc. to DIN and VDE screwdriver slot and cross-slotted PH, VDE-insulated acc. to DIN EN 60900, high-grade chrome-molybdenum steel blade, chrome-plated, phosphated driven tip, dual-material handle, 5-edge grip head, elongated hole in handle
- > **Hexagon socket key:** To DIN ISO 2936, hardened throughout, chrome-vanadium steel, phosphated, in holder
- > **Flat chisel:** To DIN 6453, cutting edge and head ground, impact end tempered, chrome-vanadium steel
- > **Water pump pliers:** To DIN 8976 Form C, lengthways-serrated gripping surfaces, box joint, 7 settings, chrome vanadium steel, powder-coated
- > **Phase tester:** Max. 250 volt, black gun-metal tip, red plastic jacket, anti-slip handle surface, synthetic clip, to DIN 0680-6:1977-04
- > **VDE Cable knife:** VDE-insulated to DIN EN 60900, strong straight blade, straight cutting edge, protective cap, dual-material handle, hands-friendly transfer of force
- > **Half-round file:** To DIN 7261, dual-material handle, hands-friendly transfer of force, hole for hanging up
- > **Utility knife:** Blade 18 mm, synthetic housing, metal blade guide, one-handed operation, 5 spare blades (100mm long, 0.4mm thick), with sharpener
- > **Adjustable spanner:** 15° jaw position, polished head with lasered scale, 40-50 HRC, chrome-vanadium steel, chrome-plated
- > **Bit box:** Drive adapter with magnetic bit locking, hexagon drive to DIN 3126 ISO 1173 - C 6.3, machine operated, phosphated, plastic box
- > **Bit screwdriver:** Dual-material handle, hex recess drive to DIN 3126 - D 6.3 (1/4") for bits, magnet, elongated hole in the handle, chrome-vanadium steel

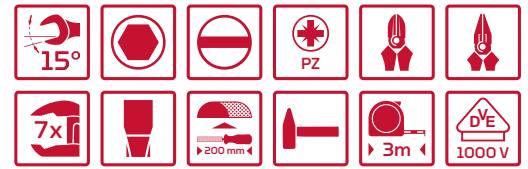

R21600072



R21650072

Three variants of the BASIS assortment are available.

Contents		pieces	
Double open-ended spanners 6x7 8x9 10x11 12x13 14x15 16x17 18x19 20x22 mm, Engineers' hammer 300 g, Combination pliers 180 mm, Power side cutter 200 mm, Pincer 200 mm, Multifunction saw 300 mm, Tape measure 3 m, Blue pencil 175 mm, Screwdriver slotted 4 5.5 6.5 mm, Screwdriver cross-slotted PZ 1 2, Hexagon socket key set, 9 pcs, 1.5 2 2.5 3 4 5 6 8 10 mm, VDE screwdriver slotted 3 mm 170 mm, VDE Screwdriver cross-head PH 2 210 mm, Flat cold chisel 125 mm, Water pump pliers 10", 250 mm, Phase tester 3 mm 135 mm, VDE cable cutter 185 mm, Half-round file 310 mm, Utility knife with pencil sharpener 175 mm, Adjustable spanner 8" 200 mm, Bit box, 32 pcs, Bit screwdriver 210 mm, Spirit level 300 mm		72	5.6

Code	No.	Contents	pieces	
3301627	R21000072	Tool set BASIC, loose	72	5.6
3301628	R21600072	Tool set BASIS in tool box R20600073	72	10.6
3301630	R21650072	Tool set BASIC in tool case R20650066 72	72	10.4

R2100 0059

UNIVERSAL SET ALLROUND

59 pieces



- > **Combination spanner:** To DIN 3113, Form A ISO 3318, ISO 7738, ring side angled 15° jaw position, surface matt satin, plate-chromed, chrome-vanadium steel
- > **Engineers' hammer:** Forged hammer head of tempered steel, inductively hardened striking surfaces, to DIN 1041, ash handle, paint-coated shaft end, ring wedge
- > **Combination pliers:** To DIN ISO 5746, gripping zones for flat and round material, inductively hardened cutting edges, dual-material handle, chrome-vanadium steel
- > **Side cutters:** To DIN ISO 5749, slender head, inductively hardened, long cutting edges, dual-material handle, chrome-vanadium steel
- > **2C screwdriver:** Slot and cross-slotted PH, PZ, to DIN, high-grade chrome-molybdenum steel blade, chrome-plated, phosphated driven tip, dual-material handle, 5-edge grip head, elongated hole in handle
- > **Hexagon socket key:** To DIN, hardened throughout, chrome-vanadium steel, phosphated, in holder
- > **Flat and cross-cut chisel:** To DIN, cutting edge and head ground, impact end tempered, chrome-vanadium steel
- > **Hexagonal punch:** To DIN 6458, impact end annealed, chrome-vanadium steel
- > **Centre punch, hexagonal:** To DIN 7250, impact end annealed, chrome-vanadium steel
- > **Water pump pliers:** To DIN 8976 Form C, lengthways-serrated gripping surfaces, box joint, 7 settings, chrome vanadium steel, powder-coated
- > **Phase tester:** Max. 250 volt, black gun-metal tip, red plastic jacket, anti-slip handle surface, synthetic clip, to DIN 0680-6:1977-04
- > **Round and flat files:** To DIN 7261, dual-material handle, hands-friendly transfer of force, hole for hanging up
- > **Adjustable spanner:** 15° jaw position, polished head with lasered scale, 40-50 HRC, chrome-vanadium steel, chrome-plated
- > **Wood sectioned folding ruler:** Metric dual scale, Accuracy Class III, EC-design approval for continuous mm division, beech wood with through-riveted joints
- > **Carbide scriber:** Pencil and carbide scriber in one, straight form, retractable nib, metal housing, attaching clip



R21650059

Two variants of the ALLROUND assortment are available.

Contents			pieces	
Combination spanner 8 9 10 11 12 13 14 15 16 17 18 19 21 22 24 27 mm, Adjustable spanner 6" 12", Scriber 150 mm, Wood sectioned folding ruler 2 m,			59	8.6
Screwdriver slotted 4 5.5 6.5 mm, Screwdriver cross-slotted PH 1 2, Screwdriver cross-slotted PZ 1 2, Hexagon socket key set, 9 pcs, 1.5 2 2.5 3 4 5 6 8 10 mm,				
Hexagon socket key set, 9 pcs, TX T10 T15 T20 T25 T27 T30 T40 T45 T50, Phase tester 3 mm 135 mm, Combination plier 180 mm, Side cutter 160 mm,				
Water pump pliers 10", 250 mm, Engineers' hammer 300 g 800 g, Flat cold chisel 250 mm, Cross-cut chisel 150 mm, Drift punch 3 4 5 mm 150 mm, Centre punch 5 mm 120 mm, Flat file 310 mm, Round file 310 mm				
Code	No.	Contents	pieces	
3301632	R21000059	Tool set ALLROUND, loose	59	8.6
3301635	R21650059	Tool set ALLROUND in tool case R20650066	59	10.4

R21000057

UNIVERSAL SET MECHANIC

57 pieces



Socket wrench tools:

- > Coupler in acc. with DIN 3120, ISO 1174, with ball locking device
- > Square drive acc. to DIN 3120, ISO 1174, with ball retention groove
- > 2C reversible ratchet, lever for reversible right and left hand operation, push button release, fine-toothed, oval head, dual-material handle, hands-friendly transfer of force, for sockets
- > Socket 1/2", hex, metric, short design based on DIN 3124, ISO 2725
- > Spark plug socket 1/2" with pressed-in holding rubber
- > Spark plug socket 1/2" with pressed-in holding rubber and additional drive hex AF 24
- > Socket extension 1/2":
- > Universal joint 1/2", joint bolted on, design to DIN 3123 - C 12,5
- > For hand-operated bolting operations
- > Chrome-vanadium steel, matt satin chrome-plated
- > Holding rail, for equipping with adaptors for 1/2" sockets, aluminium
- > **Combination spanner:** To DIN 3113, Form A ISO 3318, ISO 7738, ring side angled 15° jaw position, surface matt satin, plate-chromed, chrome-vanadium steel
- > **Engineers' hammer:** Forged hammer head of tempered steel, inductively hardened striking surfaces, to DIN 1041, ash handle, paint-coated shaft end, ring wedge
- > **Combination pliers:** To DIN ISO 5746, gripping zones for flat and round material, inductively hardened cutting edges, dual-material handle, chrome-vanadium steel
- > **Side cutters:** To DIN ISO 5749, slender head, inductively hardened, long cutting edges, dual-material handle, chrome-vanadium steel
- > **2C screwdriver:** Slot and cross-slotted PH, to DIN, high-grade chrome-molybdenum steel blade, chrome-plated, phosphated driven tip, dual-material handle, 5-edge grip head, elongated hole in handle
- > **Hexagon socket key:** To DIN, hardened throughout, chrome-vanadium steel, phosphated, in holder
- > **Water pump pliers:** To DIN 8976 Form C, lengthways-serrated gripping surfaces, box joint, 7 settings, chrome vanadium steel, powder-coated
- > **Phase tester:** Max. 250 volt, 1-component handle, transparent plastic, metal clip
- > **Tape measure:** ABS dual-material housing, clip, nylon-coated tape, mm-graduation, with tape rewind and lock, magnetic stop, Accuracy Class II



R21650057

Two variants of the MECHANIC assortment are available.

Contents		pieces	kg
Combination spanner 6 7 8 9 10 11 12 13 14 15 16 17 18 19 mm, Screwdriver slotted 3 4 5.5 6.5 mm, Screwdriver cross-head PH 0 1 2, Phase tester 3 mm 144 mm, Hexagon socket key set, 9 pcs, 1.5 2 2.5 3 4 5 6 8 10 mm, Socket 1/2" hexagon 8 10 11 12 13 14 15 16 17 18 19 22 24 mm, 2C reversible ratchet 1/2", Extension 1/2" 125 250 mm, Universal joint 1/2" 66 mm, Spark plug socket 1/2" 16 21 mm 65 mm, Holding rail 8", Adaptor 1/2" for holding rail, Combination plier 180 mm, Side cutter 160 mm, Water pump pliers 10", 250 mm, Engineers' hammer 300 g, Tape measure 3 m		57	5.5

Code	No.	Contents	pieces	kg
3301637	R21000057	Tool set MECHANIC, loose	57	5.5
3301640	R21650057	Tool set MECHANIC in tool case R20650066 57	57	10.3

R21000108

UNIVERSAL SET ALL-IN

108 pieces

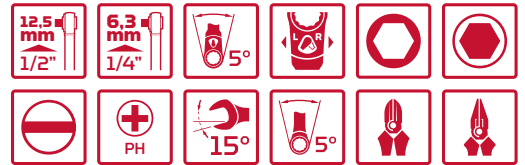

Socket wrench tools:

- > Coupler in acc. with DIN 3120, ISO 1174, with ball locking device
- > Square drive acc. to DIN 3120, ISO 1174, with ball retention groove
- > **2C reversible ratchet 1/4" + 1/2"**: Lever for reversible right and left hand operation, push button release, fine-toothed, oval head, dual-material handle, hands-friendly transfer of force, for sockets
- > Socket 1/2", hex, metric, short design based on DIN 3124, ISO 2725
- > Socket extension
- > **Universal joint**: Joint bolted on, design to DIN 3123 - C 12.5
- > For hand-operated bolting operations
- > Chrome-vanadium steel, matt satin chrome-plated
- > Holding rail, for equipping with adaptors for 1/2" sockets, aluminium
- > **Ratchet wrench, metric**: Based on DN 3113, ISO 3318, straight, 15° jaw position, surface matt satin plate-chromed, chrome-vanadium steel
- > **Engineers' hammer**: Forged hammer head of tempered steel, inductively hardened striking surfaces, to DIN 1041, ash handle, paint-coated shaft end, ring wedge
- > **Combination pliers**: To DIN ISO 5746, gripping zones for flat and round material, inductively hardened cutting edges, dual-material handle, chrome-vanadium steel
- > **Power side cutter**: To DIN ISO 5749, high degree of cutting performance, inductively hardened, long cutting edges, dual-material handle, chrome-vanadium steel
- > **Bent nose telephone pliers, straight**: To DIN ISO 5745, straight gripping surfaces, lengthways-serrated, inductively hardened cutting edges, dual-material handle, chrome-vanadium steel
- > **Tape measure**: ABS dual-material housing, clip, nylon-coated tape, mm-graduation, with tape rewind and lock, magnetic stop, Accuracy Class II
- > **2C screwdriver**: Slot and cross-slotted PH, to DIN, high-grade chrome-molybdenum steel blade, chrome-plated, phosphated driven tip, dual-material handle, 5-edge grip head, elongated hole in handle
- > **Hexagon socket key**: To DIN ISO 2936, hardened throughout, chrome-vanadium steel, phosphated, in holder
- > **Flat chisel**: To DIN 6453, cutting edge and head ground, impact end tempered, chrome-vanadium steel
- > **Water pump pliers**: To DIN 8976 Form C, lengthways-serrated gripping surfaces, box joint, 7 settings, chrome vanadium steel, powder-coated
- > **Hexagonal punch**: To DIN 6458, impact end annealed, chrome-vanadium steel
- > **Centre punch, hexagonal**: To DIN 7250, impact end annealed, chrome-vanadium steel
- > **Pin punch, octagonal**: To DIN 6450, impact end annealed, chrome-vanadium steel
- > **Utility knife**: Blade 18 mm, synthetic housing, metal blade guide, one-handed operation, 5 spare blades (100mm long, 0.4mm thick), with sharpener
- > **Bit box**: Drive adapter with magnetic bit locking, hexagon drive to DIN 3126 ISO 1173 - C 6.3, machine operated, phosphated, plastic box
- > **Bit screwdriver**: Dual-material handle, hex recess drive to DIN 3126 - D 6.3 (1/4") for bits, magnet, elongated hole in the handle, chrome-vanadium steel



R21650108

Two variants of the ALL-IN assortment are available.

Contents			pieces	kg
2C reversible ratchet 1/2" 250 mm, Extension 1/2" 125 250 mm, Universal joint 1/2" 66 mm, Socket 1/2" hexagon 8 10 11 12 13 14 15 16 17 18 19 22 24 27 30 32 mm			108	8.6
2C reversible ratchet 1/4" 150 mm, Extension 1/4" 100 mm, Socket 1/4" hexagon 4 4.5 5 5.5 6 7 8 9 10 11 12 13 14 mm, Bit box, 32 pcs, Bit screwdriver 210 mm, Universal joint 1/4" 33 mm, 2 x Holding rail 8", Adaptor 1/4" + 1/2" for holding rail, Ratchet wrench set 8 9 10 11 12 13 14 15 17 19 mm, Screwdriver slotted 3 4 5.5 6.5 mm, Screwdriver cross-slotted PH 1 2, Hexagon socket key set, 9 pcs, 1.5 2 2.5 3 4 5 6 8 10 mm, Combination plier 180 mm, Power side cutter 200 mm, Bent nose telephone pliers, straight 200 mm, Water pump pliers 10", 250 mm, Engineers' hammer 500 g, Flat cold chisel 150 mm, Centre punch 4 mm 120 mm, Pin punch 4 mm 120 mm, Drift punch 4 mm 150 mm, Utility knife with pencil sharpener 175 mm, Tape measure 5 m				
Code	No.	Contents	pieces	kg
3301642	R21000108	Tool set ALL-IN, loose	108	8.6
3301645	R21650108	Tool set ALL-IN in tool case R20650066	108	13.4

R21000042

SPECIAL SET ELECTRO-TECHNICS

42 pieces

- > **Double open-ended spanner:** To DIN 3110, ISO 3318, ISO 1085, ISO 10102, 15° jaw position, surface matt satin plate-chromed, chrome-vanadium steel
- > **VDE Combination pliers:** To DIN ISO 5746, meets requirements of VDE 0682 Part 201 and EN/EC 60900, with gripping zones for flat and round material, inductively hardened cutting edges, dual-material handle, chrome-vanadium steel
- > **VDE power side cutter:** To DIN ISO 5749, meets requirements of VDE 0682 Part 201 and EN/EC 60900 high cutting performance, slim head form, inductively hardened cutting edges, dual-material handle, chrome-vanadium steel
- > **VDE Bent nose telephone pliers, angled:** To DIN ISO 5745, meets requirements of VDE 0682 Part 201 and EN/EC 60900, 45°-angled gripping surfaces, lengthways-serrated, inductively hardened cutting edges, dual-material handle, forged
- > **VDE Cable knife:** VDE-insulated to DIN EN 60900, stable, partially insulated and replaceable blade, straight cutting edge, protective cap, safety handle of impact-resistant plastic
- > **VDE screwdriver slotted and cross-slotted PH:** VDE-insulated in acc. with DIN EN 60900, high-grade chrome-molybdenum steel blade, chrome-plated, phosphated driven tip, dual-material handle, 5-edge grip head, elongated hole in handle
- > **Hexagon socket key:** To DIN ISO 2936, hardened throughout, chrome-vanadium steel, phosphated, in holder
- > **Engineers' hammer:** Forged hammer head of tempered steel, inductively hardened striking surfaces, to DIN 1041, ash handle, paint-coated shaft end, ring wedge
- > **Club hammer:** Forged hammer head of tempered steel, inductively hardened striking surfaces, to DIN 6475, ash handle, paint-coated shaft end, ring wedge
- > **Flat chisel:** To DIN 6453, cutting edge and head ground, impact end tempered, chrome-vanadium steel
- > **Electrician's chisel, square:** Cutting edge and head ground, impact end annealed, chrome-vanadium steel
- > **Point chisel, octagonal:** To DIN 7256, cutting edge and head ground, impact end tempered, chrome-vanadium steel
- > **Centre punch, hexagonal:** To DIN 7250, impact end annealed, chrome-vanadium steel
- > **Phase tester:** Max. 250 volt, black gun-metal tip, red plastic jacket, anti-slip handle surface, synthetic clip, to DIN 0680-6:1977-04
- > **Wood sectioned folding ruler:** Metric dual scale, Accuracy Class III, EC-design approval for continuous mm division, beech wood with through-riveted joints
- > **Carbide scriber:** Pencil and carbide scriber in one, straight form, retractable nib, metal housing, attaching clip
- > **Voltage tester:** To DIN ISO 0680, 8 LED displays, DC and AC measurement, Protection classification IP65
- > **Spirit level:** Smooth aluminium rectangular profile, two acrylic vials, measurement accuracy: +/- 0.5 mm/m, powder-coated, impact-resistant end cap
- > **Scraper:** For minor improvements/repairs, wooden handle, with hanging-up hole
- > **Blue pencil:** Oval form

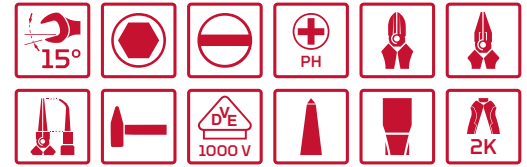

Code	No.	Contents	pieces	
3301646	R21000042	Double open-ended spanners 6x7 8x9 10x11 12x13 14x15 16x17 18x19 20x22 21x23 24x27 mm Engineers' hammer 300 g, Club hammer 1000 g, Carbide scriber with clip 150 mm, Centre punch 5 mm 120 mm, Flat cold chisel 250 mm, Point chisel 250 mm, Electricians' chisel 250 mm, Voltage tester 6-400 V AC/DC, Phase tester 3 mm 135 mm, Wood sectioned folding ruler 2 m, Scraper 60 mm, VDE Screwdriver slotted 2.5 3 4 5.5 mm, VDE Screwdriver cross-head PH 1 2, VDE Combination pliers 180 mm, VDE Side cutter 160 mm, VDE Bent nose telephone pliers, angled 200 mm, VDE cable cutter 185 mm, Hexagon socket key set, 9 pcs, 1.5 2 2.5 3 4 5 6 8 10 mm, Spirit level 300 mm, Blue pencil 175 mm	42	7.0

R21010000

TOOL SET

in foam modules, 81 pieces



Socket wrench tools:

- > Coupler in acc. with DIN 3120, ISO 1174, with ball locking device
- > Square drive acc. to DIN 3120, ISO 1174, with ball retention groove
- > **2C reversible ratchet 1/2"**: To DIN 3120 - A 12.5, ISO 1174, lever for right and left-hand operation, push button release, fine-toothed, oval form, dual-material handle
- > Socket extension 1/2"
- > Sliding T bar 1/2", with slide, to DIN 3122, ISO 3315
- > **Universal joint 1/2"**: Joint bolted on, design to DIN 3123 - C 12.5
- > Chrome-vanadium steel, matt satin chrome-plated
- > Square drive acc. to DIN 3120, ISO 1174, with ball retention groove
- > **Socket, hex:** Metric, short, to DIN 3124, ISO 2725
- > **Screwdriver bit socket 1/2" for in-hex screws:** Pressed-in, phosphated pin
- > Chrome-vanadium steel, matt satin chrome-plated
- > For hand-operated bolting operations
- > **Combination spanner:** To DIN 3113, Form A ISO 3318, ISO 7738, ring side angled 15° jaw position, surface matt satin, plate-chromed
- > **Hexagon socket key set:** To DIN ISO 2936, hardened throughout, phosphated
- > Chrome-vanadium steel
- > **Water pump pliers:** To DIN 8976 Form C, lengthways-serrated gripping surfaces, box joint, 7 settings, chrome vanadium steel, powder-coated
- > **Combination pliers:** To DIN ISO 5746, inductively hardened cutting edges, dual-material handle, forged
- > **Bent nose telephone pliers:** To DIN ISO 5745, straight gripping surfaces, lengthways-serrated, inductively hardened cutting edges, dual-material handle, forged
- > **Side cutters:** To DIN ISO 5749, slender head, inductively hardened, long cutting edges, dual-material handle, forged
- > **Engineers' hammer:** Forged hammer head of tempered steel, inductively hardened striking surfaces, to DIN 1041, ash handle, paint-coated shaft end, ring wedge
- > **Flat cold chisel, flat oval:** To DIN 6453, cutting edge and head ground, impact end tempered, chrome-vanadium steel
- > **Cross-cut chisel, flat oval:** To DIN 6451, cutting edge, sides and head ground, impact end tempered, chrome-vanadium steel
- > **Hexagonal punch:** To DIN 6458, impact end annealed, chrome-vanadium steel
- > **Centre punch, hexagonal:** To DIN 7250, impact end annealed, chrome-vanadium steel
- > **Pin punch, octagonal:** To DIN 6450, impact end annealed, chrome-vanadium steel
- > **2C screwdriver slotted and PH:** To DIN, high-grade chrome-molybdenum steel blade, chrome-plated, phosphated driven tip, dual-material handle, 5-edge grip head, elongated hole in handle
- > **2C screwdriver TX:** Chrome-molybdenum steel blade, chrome-plated, phosphated driven tip, dual-material handle, 5-edge grip head, elongated hole in handle
- > **Utility knife:** Blade 25 mm, synthetic housing, metal blade guide, one-handed operation, 5 spare blades



Code	No.	Contents	pieces	
3301655	R21010000	R22150013 Screwdriver set in the 1/3 module foam module R22150018 Pliers set in the 1/3 module foam module R22150019 Hammer and chisel set in the 1/3 module foam module R22150009 Socket set 1/2" in the foam module R22150008 Ratchet and accessories 1/2" in the 1/3 module in the foam module R22150015 Screwdriver set in the 1/3 foam module R22250000 Combination spanner set and hexagon socket keys in the 2/3 foam module R93200025 Utility knife with 5 spare blades	81	13.0

R21010002

TOOL SET

in foam modules, 166 pieces



Socket wrench tools:

- > Coupler in acc. with DIN 3120, ISO 1174, with ball locking device
- > Square drive acc. to DIN 3120, ISO 1174, with ball retention groove
- > Chrome-vanadium steel, matt satin chrome-plated
- > **2C reversible ratchet 1/4"**: To DIN 3120 - A 6.3, ISO 1174, lever for right and left-hand operation, push button release, fine-toothed, oval form, dual-material handle
- > **Square plug-in handle 1/4"**: 1-component handle with in-hex
- > **Socket 1/4" hexagon**: Metric, short, to DIN 3124, ISO 2725
- > **Screwdriver bit socket 1/4" for in-hex screws**: Pressed-in, phosphated pin
- > Screwdriver bit socket 1/4" slotted, PH, PZ, TX with drill hole: Pressed-in, phosphated pin
- > Socket extension 1/4"
- > **Sliding T-handle with slide 1/4"**: Acc. to DIN 3122, ISO 3315
- > **Universal joint 1/4"**: Joint bolted on, design to DIN 3123 - C 6.3
- > **2C reversible ratchet 1/2"**: To DIN 3120 - A 12.5, ISO 1174, lever for right and left-hand operation, push button release, fine-toothed, oval form, dual-material handle
- > Socket extension 1/2"
- > Sliding T bar 1/2", with slide, to DIN 3122, ISO 3315
- > **Universal joint 1/2"**: Joint bolted on, design to DIN 3123 - C 12.5
- > **Socket, hex**: Metric, short, to DIN 3124, ISO 2725
- > **Screwdriver bit socket 1/2" for in-hex screws**: Pressed-in, phosphated pin
- > **Ratchet wrenches**: Based on DIN 3113, ISO 3318, ring offset 15°, reversible for right and left-hand operation, 15° jaw position, surface matt satin chrome-plated
- > **Hexagon socket key set**: To DIN ISO 2936, hardened throughout, phosphated
- > Chrome-vanadium steel
- > **Flat ring spanner**: To DIN 838, ISO 3318, ISO 1085, ISO 10104, 5° offset, chrome vanadium steel, surface matt satin, chrome-plated
- > **Water pump pliers**: To DIN 8976 Form C, lengthways-serrated gripping surfaces, box joint, 7 settings, chrome vanadium steel, powder-coated
- > **Combination pliers**: To DIN ISO 5746, inductively hardened cutting edges, dual-material handle, forged
- > **Bent nose telephone pliers**: To DIN ISO 5745, straight gripping surfaces, lengthways-serrated, inductively hardened cutting edges, dual-material handle, forged
- > **Side cutters**: To DIN ISO 5749, slender head, inductively hardened, long cutting edges, dual-material handle, forged
- > **Circlip pliers**: To DIN 5254 Form A, straight precision tips, opening spring, DIN 471 for retaining rings, DIN 983
- > To DIN 5254 Form B, angled precision tips, opening spring, DIN 471 for retaining rings, DIN 983
- > To DIN 5256 Form C, straight precision tips, opening spring, DIN 472 for retaining rings, DIN 984
- > To DIN 5256 Form D, 90° angled precision tips, DIN 472 for retaining rings, DIN 984
- > Dipped handle protectors
- > Chrome-vanadium steel
- > **Engineers' hammer**: Forged hammer head of tempered steel, inductively hardened striking surfaces, to DIN 1041, ash handle, paint-coated shaft end, ring wedge
- > **Flat cold chisel, flat oval**: To DIN 6453, cutting edge and head ground, impact end tempered, chrome-vanadium steel
- > **Cross-cut chisel, flat oval**: To DIN 6451, cutting edge, sides and head ground, impact end tempered, chrome-vanadium steel
- > **Hexagonal punch**: To DIN 6458, impact end annealed, chrome-vanadium steel
- > **Centre punch, hexagonal**: To DIN 7250, impact end annealed, chrome-vanadium steel
- > **Pin punch, octagonal**: To DIN 6450, impact end annealed, chrome-vanadium steel
- > **2C screwdriver**: Slot and cross-slotted PZ, to DIN, high-grade chrome-molybdenum steel blade, chrome-plated, phosphated driven tip, dual-material handle, 5-edge grip head, elongated hole in handle
- > **2C screwdriver TX**: Chrome-molybdenum steel blade, chrome-plated, phosphated driven tip, dual-material handle, 5-edge grip head, elongated hole in handle
- > **Digital measuring calliper**: LCD display, reset setting, precision roller adjustment, mm/inch changeover, ground tips, in box incl. spare battery, operating instructions, PC interface, locking screw, thread table on the back
- > **Clamp locking plier**: Lengthways-serrated grip surfaces, setting screw and release lever, one-hand operation, surface chrome-plated, chrome vanadium steel
- > **Half-round file**: To DIN 7261, dual-material handle, hands-friendly transfer of force, hole for hanging up

- > **Tape measure**: ABS dual-material housing, clip, nylon-coated tape, mm-graduation, with tape rewind and lock, magnetic stop, Accuracy Class II
- > **Utility knife**: Blade 25 mm, synthetic housing, metal blade guide, one-handed operation, 5 spare blades
- > **(De)magnetizer**: Magnetizer for bolting and gripping tools, demagnetizer for tools
- > **Feeler gauge set**: Protective handle, folding, blades tapering to a cone, of hardened spring steel
- > **Bit box**: Drive adapter with magnetic bit locking, hexagon drive to DIN 3126 ISO 1173 - C 6.3, machine operated, phosphated, plastic box





Code	No.	Contents	pieces	kg
3301657	R21010002	R22150006 Socket set 1/4" in the 1/3 foam module, R22150000 Double-ended ring spanner in the 1/3 foam module, R22150018 Pliers set in the 1/3 foam module, R22150019 Hammer and chisel set in the 1/3 module foam module, R22150009 Socket set 1/2" in the 1/3 foam module, R22150008 Ratchet and accessories 1/2" in the foam module, R22250001 Ratchet wrench set in the 2/3 foam module, R22150014 Screwdriver set in the 1/3 foam module, R22150015 Screwdriver set in the 1/3 foam module, R22150017 Circlip pliers set in the 1/3 foam module, R27200010 Clamp locking plier 10" 225 mm, R33005031 Bit box 1/4" 32 pieces, R38990000 (De)magnetizer R94420021 Digital measuring calliper, R93200025 Utility knife with 5 spare blades 175 mm, R94650013 Feeler gauge set, R93160052 Half-round file 310 mm, R94550003 Tape measure 3 m	166	19.0

R21010004 TOOL SET

in foam modules, 129 pieces

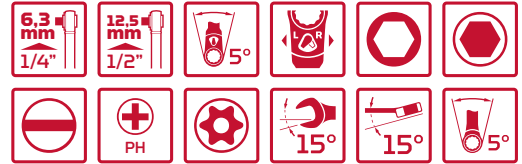

- > Coupler in acc. with DIN 3120, ISO 1174, with ball locking device
- > Square drive acc. to DIN 3120, ISO 1174, with ball retention groove
- > **2C reversible ratchet 1/4" + 1/2"**: Lever for reversible right and left hand operation, push button release, fine-toothed, oval head, dual-material handle, hands-friendly transfer of force, for sockets
- > **Square plug-in handle 1/4"**: 1-component handle with in-hex
- > **Socket 1/4" + 1/2"**: hex, metric, short and long type based on DIN 3124, ISO 2725
- > Spark plug socket 1/2" with pressed-in holding rubber
- > Spark plug socket 1/2" with pressed-in holding rubber and additional drive hex AF 24
- > **Screwdriver bit socket 1/4" + 1/2" for in-hex screws**: Pressed-in, phosphated pin
- > **Screwdriver bit socket 1/4" slotted, PH, PZ, TX with drill hole**: Pressed-in, phosphated pin
- > **Sliding T-handle with slide 1/4" + 1/2"**: Acc. to DIN 3122, ISO 3315
- > Socket extension 1/4" + 1/2"
- > **Universal joint 1/4" + 1/2"**: Joint bolted on, design to DIN 3123 - C 12.5
- > **Adjustable spanner**: 15° jaw position, polished head with lasered scale
- > Chrome-vanadium steel, matt satin chrome-plated
- > **Ratchet wrenches**: Based on DN 3113, ISO 3318, straight, 72-toothed ratchet mechanism, 5° working angle, 15° jaw position, surface matt satin plate-chromed, chrome-vanadium steel
- > **Double open-ended spanner**: To DIN 3110, ISO 3318, ISO 1085, ISO 10102, 15° jaw position, surface matt satin chrome-plated, chrome-vanadium steel
- > **Combination pliers**: To DIN ISO 5746, gripping zones for flat and round material, inductively hardened cutting edges, dual-material handle, chrome-vanadium steel
- > **Side cutters**: To DIN ISO 5749, slender head, inductively hardened, long cutting edges, dual-material handle, chrome-vanadium steel
- > **Bent nose telephone pliers, straight**: To DIN ISO 5745, straight gripping surfaces, lengthways-serrated, inductively hardened cutting edges, dual-material handle, chrome-vanadium steel
- > **Water pump pliers**: To DIN 8976 Form C, lengthways-serrated gripping surfaces, box joint, 7 settings, chrome vanadium steel, powder-coated
- > **2C screwdriver**: Slot and cross-slotted PH, to DIN, high-grade chrome-molybdenum steel blade, chrome-plated, phosphated driven tip, dual-material handle, 5-edge grip head, elongated hole in handle
- > **2C screwdriver TX**: High-grade chrome-molybdenum steel blade, chrome-plated, phosphated driven tip, dual-material handle, 5-edge grip head, elongated hole in handle
- > **Engineers' hammer**: Forged hammer head of tempered steel, inductively hardened striking surfaces, to DIN 1041, ash handle, paint-coated shaft end, ring wedge
- > **Flat chisel**: To DIN 6453, cutting edge and head ground, impact end tempered, chrome-vanadium steel
- > **Cross-cut chisel**: To DIN 6451, cutting edge, sides and head ground, impact end tempered, chrome-vanadium steel
- > **Hexagonal punch**: To DIN 6458, impact end annealed, chrome-vanadium steel
- > **Centre punch, hexagonal**: To DIN 7250, impact end annealed, chrome-vanadium steel
- > **Pin punch, octagonal**: To DIN 6450, impact end annealed, chrome-vanadium steel

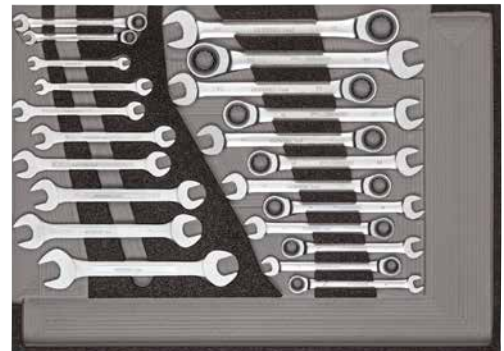
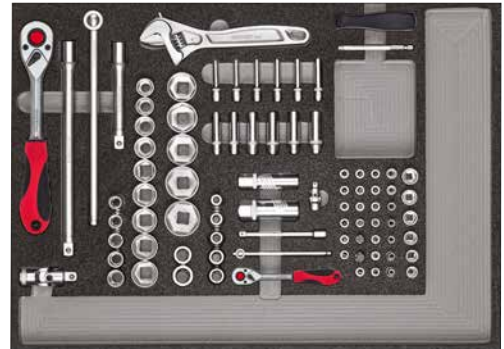

Code	No.	Contents	pieces	kg
3301679	R21010004	R22350000 Socket set 1/4" + 1/2" and accessories in the 3/3 foam module R22350005 Screwdriver, pliers, hammer and chisel set in the 3/3 foam module R22350006 Ratchet wrench, double-ended spanner set in the 3/3 foam module	129	13.6

MOBILE TOOL STORAGE

024 - 027



R20600073

TOOL BOX

5 compartments, empty

- > Made from sheet steel
- > Lockable with padlock
- > With riveted joints
- > Highly stable
- > Without tools



Code	No.	W	H	D	
3301658	R20600073	535	260	210	5.0

R20750063

TOOL BOX

empty

- > Ideal for storage of tools and accessories
- > Of rugged, impact-resistant plastic (polypropylene)
- > Four sorting boxes with adjustable compartments for incidentals
- > Ample space for storage under the lid for e.g. cordless screwdrivers
- > Lockable with padlock
- > Handle folds away flush
- > Can also serve as a stool thanks to its high load capacity
- > Without tools



Code	No.	W	D	H	max. load capacity kg	
3301659	R20750063	420	303	400	150	4.9

R20650066

TOOL CASE

empty

- > Strong impact-resistant plastic case
- > Four plastic feet for stability
- > Lockable metal locks, 2 keys
- > 1 document folder in lid, fixed with Velcro®, detachable
- > 1 lid tool pallet with pouches on 2 sides
- > 1 bottom tool pallet with pouches on one side
- > Bottom tray with variable dividers (large or small parts)
- > Without tools



Code	No.	W	D	H	max. load capacity kg	
3301660	R20650066	445	180	380	30	4.5

R20802012

TOOL WALLET

empty

- > Water-repellent surface
- > Stable lock with adjustable strap
- > With flexible straps inside
- > **For tools up to 240 mm in length**
- > 12 compartments as standard and 1 compartment for incidentals
- > Without tools



Example of use

Code	No.
3301660	R20802012

R20702069

TOOL/LAPTOP BAG

empty

Laptop bag up to 17"

- > Padded compartment for safe transport of laptop and accessories
- > Compartment for smartphone
- > Compartments for pencils/pens
- > Small parts compartments, open and closable
- > Compartment for ring binder
- > Outside pocket at the back
- > Trolley holder
- > Separate carrying handles
- > Padded shoulder strap
- > Stable metal eyelets for shoulder strap

Detachable bag for tools

- > Reinforced zipper for tying to the laptop bag
- > Large, double front pocket with top and front zipper
- > 18 large inside pocket for tools
- > 26 stretch straps for tools of various diameters
- > Separate carrying handles
- > Anti-slip protection surfaces at the bottom
- > Tear and abrasion-proof fabric
- > Without tools



Code	No.	W	D	H	
3301662	R20702069	480	370	140	2.1



WORKSHOP EQUIPMENT

028 - 037



Workshop Equipment

R2015 XXXX

WORKSHOP TROLLEY MECHANIC WITH 6 DRAWERS



- > Strong, sheet steel construction, torsionally rigid, designed to take high loads
- > Working platform with ABS top
- > Sides with Euro-standard square perforation for accessories
- > 6 drawers telescopically fully extendable with individual locking (one-hand operation)
- > The individual locking device - unlockable only with a practical, concealed release bar - prevents the drawer being opened when the trolley is in motion
- > Each variably compartmentalised drawer can hold 25 kg
- > Drawer size inside: W 482 x D 345 mm, front height 4x 69 mm, 1x 144 mm, 1x 218 mm
- > Central locking with cylinder lock complete with 4 keys
- > 2 swivel casters Ø 100 mm of which one has a double-stop wheel lock, 2 castors Ø 140 mm, side projecting thus affording considerable stability
- > Without tools



Code	No.	RAL	H	W	D		max. load capacity kg	
3301663	R20150006	3020 / 7016	910	628	418	Drawers: 4 x H 69 mm 1 x H 144 mm 1 x 218 mm	210	56.0

SPARE PARTS/ACCESSORIES

Code	No.	Description	
3301719	R20901501	Spare lock with key f.MECHANIC	0.060
3301722	R20901504	Swivel castor f. workshop trolley MECHANIC	0.950
3301721	R20901503	Heavy load fixed castor f. workshop MECHANIC	0.580
3301720	R20901502	Guide rails f. drawers f.MECHANIC	0.760

R2040 0006

WORKSHOP TROLLEY MECHANIC PLUS WITH 6 DRAWERS



- > Large storage space with adjustable shelf, separately lockable
- > Strong, sheet steel construction, torsionally rigid, designed to take high loads
- > 988 x 431 mm working platform made of wood, 30 mm thick
- > Sides with Euro-standard square perforation for accessories
- > 6 drawers telescopically fully extendable with individual locking (one-hand operation)
- > Internal size of storage space: H 720 x W 355 x D 380 mm
- > The individual locking device - unlockable only with a practical, concealed release bar - prevents the drawer being opened when the trolley is in motion
- > Each variably compartmentalised drawer can hold 25 kg
- > Drawer size inside: W 482 x D 345 mm, front height 4x 69 mm, 1x 144 mm, 1x 218 mm
- > Central locking with cylinder lock complete with 4 keys
- > 2 swivel casters Ø 100 mm of which one has a double-stop wheel lock, 2 castors Ø 140 mm, side projecting thus affording considerable stability
- > Without tools



Code	No.	RAL	H	W	D		max. load capacity kg	
3301818	R20400006	3020 / 7016	935	988	431	Drawers: 4 x H 69 mm 1 x H 144 mm 1 x 218 mm Storage space: 1 x H 720 x W 355 x D 380 mm	210	81.0

SPARE PARTS/ACCESSORIES

Code	No.	Description	
3301719	R20901501	Spare lock with key f. MECHANIC	0.060
3301722	R20901504	Swivel castor f. workshop trolley MECHANIC	0.950
3301721	R20901503	Heavy load fixed castor f. workshop MECHANIC	0.580
3301720	R20901502	Guide rails f. drawers f. MECHANIC	0.760

R2156 0001

WORKSHOP TROLLEY MECHANIC WITH TOOL SET

119 pieces

- > Strong, sheet steel construction, torsionally rigid, designed to take high loads
- > Working platform with ABS top
- > Sides with square perforation for accessories
- > Storage space on the left with shelf. Internal dimensions H 720 x W 355 x D 380 mm
- > Door, left-hand door stop, lockable, H 670 x W 310 mm
- > 6 drawers telescopically fully extendable with individual locking (one-hand operation)
- > The individual locking device - unlockable only by a practical, concealed release bar - prevents the drawer being opened when the trolley is in motion
- > Each variably compartmentalised drawer can hold 25 kg
- > Drawer size inside: W 482 x D 345 mm, front height 4x 69 mm, 1x 144 mm, 1x 218 mm
- > Central locking with cylinder lock complete with 4 keys
- > 2 swivel casters Ø 100 mm, 1x with double-stop wheel lock, 2 castors Ø 140 mm, side projecting thus affording considerable stability



Code	No.	RAL	H	W	D	Contents		max. load capacity kg	
3301667	R21560001	3020 / 7016	910	628	418	R22150018 Pliers set in 1/3 module R22150006 Socket set 1/4" in 1/3 module R22150009 Socket set 1/2" in 1/3 module R22150013 Screwdriver set in 1/3 module R22150019 Hammer and chisel set in 1/3 module R22150008 Ratchet and accessories 1/2" in 1/3 module R22150015 Screwdriver set in 1/3 module R22250000 Combination spanner set and hexagon socket keys in 2/3 module R93200025 Utility knife with 5 blades R94550003 Tape measure 3 m	Drawers: 4 x H 69 mm 1 x H 144 mm 1 x 218 mm	210	70.0



R2156 0002

WORKSHOP TROLLEY MECHANIC WITH TOOL SET

166 pieces

- > Strong, sheet steel construction, torsionally rigid, designed to take high loads
- > Working platform with ABS top
- > Sides with Euro-standard square perforation for accessories
- > 6 drawers telescopically fully extendable with individual locking (one-hand operation)
- > The individual locking device - unlockable only by a practical, concealed release bar - prevents the drawer being opened when the trolley is in motion
- > Each variably compartmentalised drawer can hold 25 kg
- > Drawer size inside: W 482 x D 345 mm, front height 4x 69 mm, 1x 144 mm, 1x 218 mm
- > Central locking with cylinder lock complete with 4 keys
- > 2 swivel casters Ø 100 mm of which one has a double-stop wheel lock, 2 castors Ø 140 mm, side projecting thus affording considerable stability



Code	No.	RAL	H	W	D	Contents		max. load capacity kg	
3301668	R21560002	3020 / 7016	910	628	418	R22150006 Socket set 1/4" in 1/3 module R22150000 Double-ended ring spanner in 1/3 module R22150018 Pliers set in 1/3 module R22150019 Hammer and chisel set in 1/3 module R22150009 Socket set 1/2" in 1/3 module R22150008 Ratchet and accessories 1/2" in 1/3 module R22250001 Reversible ratchet wrench set in 2/3 module R22150014 Screwdriver set in 1/3 module R22150015 Screwdriver set in 1/3 module R22150017 Circlip pliers set in 1/3 module R27200010 Locking plier 10" R33005031 Bit box 1/4" R38990000 (De)magnetiser R94420021 Measuring calliper R93200025 Utility knife with 5 blades R94650013 Feeler gauge set, 13 pcs R93160052 Half-round file R94550003 Tape measure 3 m	Drawers: 4 x H 69 mm 1 x H 144 mm 1 x 218 mm	210	75.0

R2156 0004

WORKSHOP TROLLEY MECHANIC WITH TOOL SET

129 pieces

- > Strong, sheet steel construction, torsionally rigid, designed to take high loads
- > Working platform with ABS top
- > Sides with Euro-standard square perforation for accessories
- > 6 drawers telescopically fully extendable with individual locking (one-hand operation)
- > The individual locking device - unlockable only by a practical, concealed release bar - prevents the drawer being opened when the trolley is in motion
- > Each variably compartmentalised drawer can hold 25 kg
- > Drawer size inside: W 482 x D 345 mm, front height 4x 69 mm, 1x 144 mm, 1x 218 mm
- > Central locking with cylinder lock complete with 4 keys
- > 2 swivel casters Ø 100 mm of which one has a double-stop wheel lock, 2 castors Ø 140 mm, side projecting thus affording considerable stability

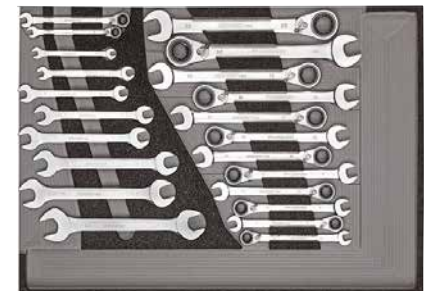
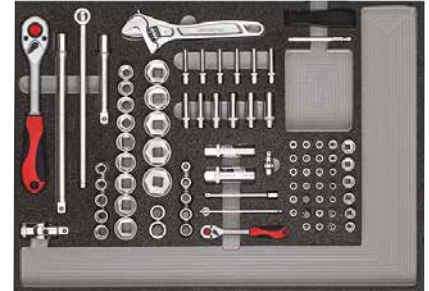

Code	No.	RAL	H	W	D	Contents	max. load capacity kg	
3301673	R21560004	3020 / 7016	910	628	418	R22350000 Tool set sockets, ratchet, accessories 1/4"-1/2" R22350005 Tool set screwdrivers, pliers, hammer, chisel R22350006 Tool set ratchet wrenches, double open-ended spanner	Drawers: 4 x H 69 mm 1 x H 144 mm 1 x 218 mm	70.0

R20901500

SET OF LENGTHWISE DIVIDERS FOR THE MECHANIC WORKSHOP TROLLEY

- > For individual drawer partitioning in workshop trolleys



Code	No.	RAL	L	H	W	pieces	
3301665	R20901500	3020 / 7016	343	60	0.8	6	0.350

R2020004

WORKSHOP TROLLEY WINGMAN WITH 4 DRAWERS



- > Strong, sheet steel construction, torsionally rigid, designed to take high loads
- > Working platform with ABS top
- > Side frame with square perforation for accessories, paper roll holder, can holder, waste basket
- > Large manoeuvring handle on both sides
- > 4 drawers telescopically fully extendable with individual locking (one-hand operation)
- > The individual drawer locking stops more than one drawer being opened - provides for considerable stability
- > Load capacity 35 kg per drawer
- > Drawer size inside: W 570 x D 410 mm
- > Drawers with anti-slip mat
- > 4 drawers - front height 83 mm
- > Large compartment with 2 lockable swing doors
- > Dimensions per door: H 386 x W 306 mm
- > Central locking with cylinder lock complete with 2 keys
- > Two swivel castors Ø 125 mm, with brake, two fixed castors



No paper roll included in delivery



Code	No.	RAL	H	W	D		max. load capacity kg	
3301688	R20200004	3020 / 7016	1034	724	470	Drawers: 4x H 83 mm Compartment: H 386 x W 612 mm	380	68.0

SPARE PARTS/ACCESSORIES

Code	No.	Description	
3301723	R20902005	Spare lock w. key f. WINGMAN	0.060
3301724	R20902006	Guide rails f. draw. f. WINGMAN	1.180
3301725	R20902007	Heavy load fixed castor f. works.trolley WINGMAN	1.300
3301820	R20902009	Swivel castor w.brake f. works.trolley WINGMAN	
3301727	R20902008	Non-slip mat 565x405mm f. works. trolley	0.100
3301696	R20240003	Tool chest WINGMAN 3 drawers 446x724x470	39.000

R22041004

WORKSHOP TROLLEY WINGMAN WITH TOOL SET

129 pieces

- > Strong, sheet steel construction, torsionally rigid, designed to take high loads
- > Working platform with ABS top
- > Side frame with square perforation for accessories, with paper roll holder, can holder, waste basket
- > Large manoeuvring handle on both sides
- > 4 drawers telescopically fully extendable with individual locking (one-hand operation)
- > The individual drawer locking stops more than one drawer being opened - provides for considerable stability
- > Load capacity 35 kg per drawer
- > Drawer size inside: W 570 x D 410 mm
- > Drawers with anti-slip mat
- > 4 drawers - front height 83 mm
- > Large compartment with 2 lockable swing doors
- > Dimensions per door: H 386 x W 306 mm
- > Central locking with cylinder lock complete with 2 keys
- > Two swivel castors Ø 125 mm, with brake, two fixed castors

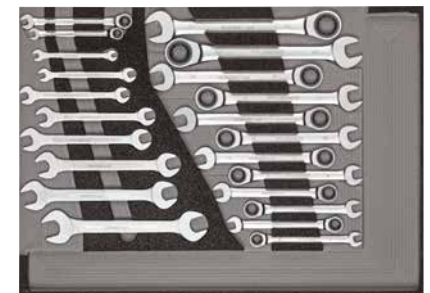
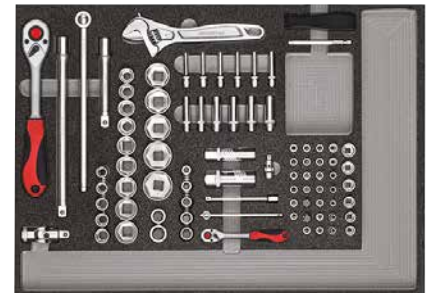

Code	No.	RAL	H	W	D	Contents	max. load capacity kg	
3301689	R22041004	3020 / 7016	1034	724	724	R22350000 Tool set sockets, ratchet, accessories 1/4"-1/2" R22350005 Tool set screwdrivers, pliers, hammer, chisel R22350006 Tool set ratchet wrenches, double open-ended spanner	Drawers: 4x H 83 mm Compartment: H 386 x W 612 mm	380 68.0

R2020 0007

WORKSHOP TROLLEY WINGMAN WITH 7 DRAWERS



- > Strong, sheet steel construction, torsionally rigid, designed to take high loads
- > Working platform with ABS top
- > Side frame with square perforation for accessories, paper roll holder, can holder, waste basket
- > Large manoeuvring handle on both sides
- > 7 drawers telescopically fully extendable with individual locking (one-hand operation)
- > The individual drawer locking stops more than one drawer being opened - provides for considerable stability
- > Load capacity 35 kg per drawer
- > Drawer size inside: W 570 x D 410 mm
- > 5 drawers - front height 83 mm
- > 2 drawers front height 155 mm
- > Drawers with anti-slip mat
- > Central locking with cylinder lock complete with 4 keys
- > Two swivel castors Ø 125 mm, with brake, two fixed castors



Code	No.	RAL	H	W	D		max. load capacity kg	
3301690	R20200007	3020 / 7016	1034	724	470	Drawers: 5x H = 83 mm 2x H = 155 mm	450	80.0

SPARE PARTS/ACCESSORIES

Code	No.	Description	
3301723	R20902005	Spare lock w. key f.WINGMAN	0.060
3301724	R20902006	Guide rails f. draw. f.WINGMAN	1.180
3301725	R20902007	Heavy load fixed castor f.works.trolley WINGMAN	1.300
3301820	R20902009	Swivel castor w.brake f.works.trolley WINGMAN	2,040
3301727	R20902008	Non-slip mat 565x405mm f.works. trolley	0.100
3301696	R20240003	Tool chest WINGMAN 3 drawers 446x724x470	39.000

R22071004

WORKSHOP TROLLEY WINGMAN WITH TOOL SET

129 pieces

- > Strong, sheet steel construction, torsionally rigid, designed to take heavy loads
- > Working platform with ABS top
- > Sides with square perforation for accessories, with paper roll holder, can holder and paper basket
- > Large manoeuvring handle on both sides
- > 7 drawers telescopically fully extendable with individual locking (one-hand operation)
- > The individual drawer locking stops more than one drawer being opened - provides for considerable stability
- > Load capacity 35 kg per drawer
- > Drawer size inside: W 570 x D 410 mm
- > 5 drawers - front height 83 mm
- > 2 drawers - front height 155 mm
- > Drawers with anti-slip mat
- > Central locking with cylinder lock complete with 4 keys
- > Two swivel castors Ø 125 mm, with brake, two fixed castors

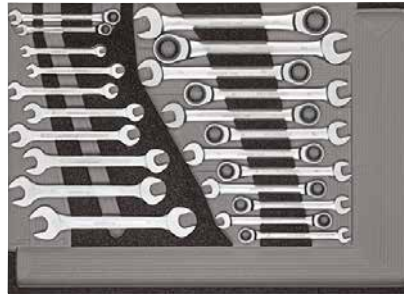
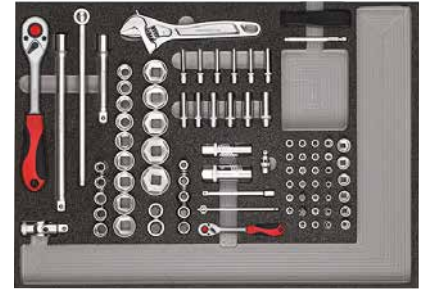

Code	No.	RAL	H	W	D	Contents	max. load capacity kg	
3301694	R22071004	3020 / 7016	1034	724	470	R22350000 Tool set sockets, ratchet, accessories 1/4"-1/2" R22350005 Tool set screwdrivers, pliers, hammer, chisel R22350006 Tool set ratchet wrenches, double open-ended spanner	Drawers: 5x H = 83 mm 2x H = 155 mm	93.6

R20240003

TOOL CHEST WINGMAN

with 3 drawers

- > Combinable with the WINGMAN workshop trolley
- > Strong, sheet steel construction, torsionally rigid, designed to take heavy loads
- > Large carrying handles on either side
- > 3 drawers with telescopic full extension and individual locking device (single-hand operation)
- > The individual drawer locking stops more than one drawer being opened - provides for considerable stability
- > Load capacity 35 kg per drawer
- > Drawer size inside: W 570 x D 410 mm
- > 3 drawers front height 83 mm
- > Drawers with anti-slip mat
- > Generous storage under lid, lid with brake, opening angle 90 degrees, usable as work surface
- > Compartment size: W 520 x D 400 x H 70 mm
- > Central locking with cylinder lock, supplied with two keys
- > Can holders on either side
- > Without tools



Code	No.	RAL	H	W	D	max. load capacity kg	
3301696	R20240003	3020 / 7016	446	724	470	Drawers: 3x H 83 mm Compartment: H 70 x W 520 x D 400 mm	39.0

TOOL MODULES

038 - 051



Foam modules are customisable

- > All shown foam modules are customisable to all common workshop trolleys.
- > Simply cut to the desired size: W 485 - 570 mm, D 345 - 410 mm, H up to 70 mm

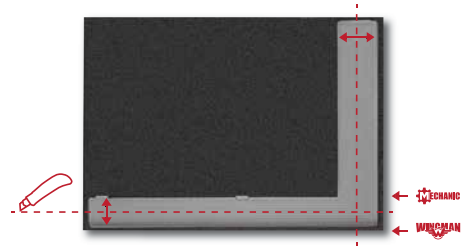

R2235 0000 SOCKET SET 1/4" + 1/2" AND ACCESSORIES

in the 3/3 foam module, 87 pieces



- > Coupler in acc. with DIN 3120, ISO 1174, with ball locking device
- > Square drive acc. to DIN 3120, ISO 1174, with ball retention groove
- > **2C Reversible ratchet:** Lever for reversible right and left hand operation, push button release, fine-toothed, oval head, dual-material handle, hands-friendly transfer of force, for sockets
- > **Square plug-in handle 1/4":** 1-component handle with in-hex
- > **Socket 1/4" + 1/2":** hex, metric, short and long type based on DIN 3124, ISO 2725
- > Spark plug socket 1/2" with pressed-in holding rubber
- > Spark plug socket 1/2" with pressed-in holding rubber and additional drive hex AF 24
- > **Screwdriver bit socket 1/4" + 1/2" for in-hex screws:** Pressed-in, phosphated pin
- > **Screwdriver bit socket 1/4" slotted:** Pressed-in, phosphated pin
- > **Screwdriver bit socket 1/4" PZ:** Pressed-in, phosphated pin
- > **Screwdriver bit socket 1/4" PH:** Pressed-in, phosphated pin
- > **Screwdriver bit socket 1/4" TX with drill hole:** Pressed-in, phosphated pin
- > **Sliding T-handle with slide 1/4" + 1/2":** Acc. to DIN 3122, ISO 3315
- > Socket extension 1/4" + 1/2"
- > **Universal joint 1/4" + 1/2":** Joint bolted on, design to DIN 3123 - C 12.5
- > **Adjustable spanner:** 15° jaw position, polished head with lasered scale
- > For hand-operated bolting operations
- > Chrome-vanadium steel, matt satin chrome-plated

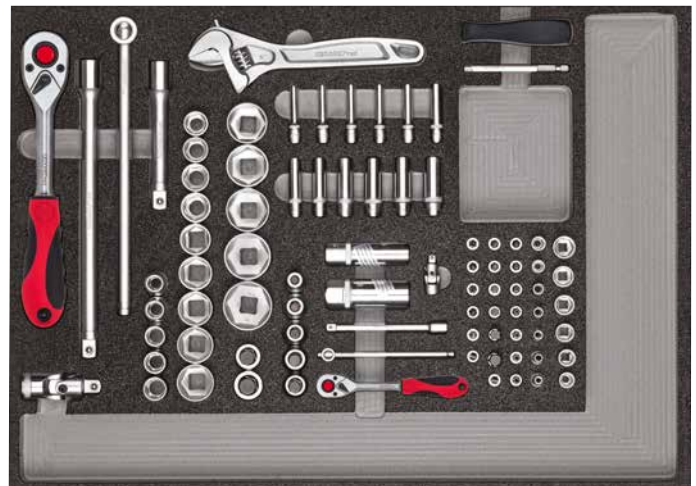

Code	No.	Contents	W	D	pieces	kg
3301681	R22350000	1/4" 2C lever reversible ratchet, fine-tooth, 72 teeth 150 mm 1/4" square plug-in handle 165 mm 1/4" socket hexagon 4 4.5 5 5.5 6 7 8 9 10 11 12 13 14 1/4" socket hexagon 4 4.5 5 5.5 6 7 8 9 10 11 12 13 50 1/4" screwdriver bit socket in-hex 3 4 5 6 8 10 37 mm 1/4" screwdriver bit socket slotted 5.5 6.5 37 mm 1/4" screwdriver bit socket cross-slotted PH 1 2 3 37 mm 1/4" screwdriver bit socket cross-head PZ 1 2 37 mm 1/4" socket TX with hole T10 T15 T20 T25 T27 T30 T40 37 mm 1/4" socket extension 100 mm 1/4" sliding T-handle with slide 115 mm 1/4" universal joint 32 mm 1/2" 2C lever reversible ratchet, fine-tooth, 72 teeth 250 mm 1/2" socket hexagon 10 11 12 13 14 15 16 17 18 19 21 22 23 24 26 27 28 30 32 1/2" screwdriver bit socket in-hex 6 7 8 9 10 12 14 55 mm 1/2" spark plug socket 16 21 mm 65 mm 1/2" socket extension 125 250 mm 1/2" sliding T-handle with slide 250 mm 1/2" universal joint 66 mm Adjustable spanner 8" 200 mm	570	410	84	5.9

R2235 0001

PLIERS, HAMMER, CHISEL SET

in the 3/3 foam module, 29 pieces

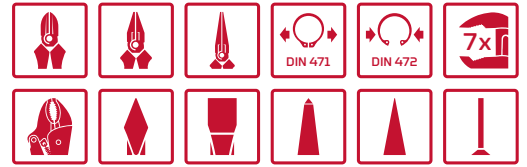

- > **Bent nose telephone pliers, straight:** To DIN ISO 5745, straight gripping surfaces, lengthways-serrated, inductively hardened cutting edges, dual-material handle, chrome-vanadium steel
- > **Side cutters:** To DIN ISO 5749, slender head, inductively hardened, long cutting edges, dual-material handle, chrome-vanadium steel
- > **Internal circlip pliers, straight and angled:** To DIN 5256, precision tips, DIN 472 for retaining rings, DIN 984, dip-insulated handles, chrome vanadium steel
- > **External circlip pliers, straight and angled:** To DIN 5254, precision tips, DIN 471 for retaining rings, DIN 983, dipped handle protectors, chrome vanadium steel
- > **Clamp locking plier:** Lengthways-serrated grip surfaces, setting screw and release lever, one-hand operation, surface chrome-plated, chrome vanadium steel
- > **Combination pliers:** To DIN ISO 5746, gripping zones for flat and round material, inductively hardened cutting edge, dual-material handle, special tool steel, forged
- > **Water pump pliers:** To DIN 8976, lengthways-serrated grip surfaces, box joint, 7 settings, head and box polished, chrome-vanadium steel, powder-coated
- > **Engineers' hammer:** Forged hammer head of tempered steel, inductively hardened striking surfaces, to DIN 1041, ash handle, paint-coated shaft end, ring wedge
- > **Flat chisel:** To DIN 6453, cutting edge and head ground, impact end tempered, chrome-vanadium steel
- > **Cross-cut chisel:** To DIN 6451, cutting edge, sides and head ground, impact end tempered, chrome-vanadium steel
- > **Centre punch:** To DIN 7250, impact end annealed, chrome-vanadium steel
- > **Pin punch:** To DIN 6450, impact end annealed, chrome-vanadium steel,
- > **Feeler gauge set:** Protective handle, folding, blades tapering to a cone, of hardened spring steel



Code	No.	Contents	W	D	pieces	kg
3301682	R22350001	Circlip pliers, external, straight 19-60 mm Circlip pliers, external, angled 19-60 mm Circlip pliers, internal, straight 19-60 mm Circlip pliers, internal, angled 19-60 mm Feeler gauge set, 13 pcs Clamp locking plier 10" 225 mm Combination plier 180 mm Telephone pliers, straight pattern 160 mm Side cutter 160 mm Water pump pliers 10" 250 mm Engineers' hammer 300 g Flat cold chisel 125 mm, 150 mm Cross-cut chisel 125 mm Centre punch 4 mm 120 mm Pin punch 4 mm 120 mm Drift punch 3 mm 150 mm	570	410	29	3.1

R2235 0002

SCREWDRIVER AND FILE SET

in the 3/3 foam module, 26 pieces

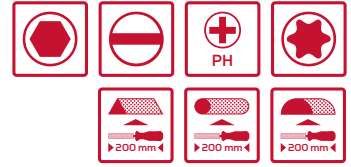

- > **2C screwdriver slotted:** To DIN 5264, high-grade chrome-molybdenum steel blade, chrome-plated, phosphated driven tip, dual-material handle, hands-friendly transfer of force, 5-edge grip head, elongated hole in handle
- > **2C screwdriver PH:** To DIN 8764, high-grade chrome-molybdenum steel blade, chrome-plated, phosphated driven tip, dual-material handle, 5-edge grip head, elongated hole in handle
- > **2C screwdriver TX:** Chrome-molybdenum steel blade, chrome-plated, phosphated driven tip, dual-material handle, 5-edge grip head, elongated hole in handle
- > **Phase tester:** Max. 250 volt, black gun-metal tip, red plastic jacket, anti-slip handle surface, synthetic clip, to DIN 0680-6:1977-04
- > **Bit screwdriver:** Dual-material handle, hex recess drive to DIN 3126 - D 6.3 (1/4") for bits, magnet, elongated hole in the handle, chrome-vanadium steel
- > **Hexagon socket key set:** To DIN ISO 2936, hardened throughout, chrome-vanadium steel, phosphated, in holder
- > **Files:** To DIN 7261, dual-material handle, file-cut 2, file length 200 mm, total length 310 mm, hole for hanging up



Code	No.	Contents	W	D	pieces	
3301683	R22350002	Screwdriver slotted 4 5.5 6.5 8 mm Screwdriver cross-slotted PH 1 2 Screwdriver TX T10 T15 T20 T25 T30 T40 Voltage tester 3 mm 135 mm Bit screwdriver 1/4" Hexagon socket key set, 9 pcs, 1.5 2 2.5 3 4 5 6 8 10 mm Half-round file 310 mm Three-edged file 310 mm Round file 310 mm	570	410	26	2.0

R2235 0004

MEASURING AND CUTTING TOOLS SET

in the 3/3 foam module, 30 pieces

- > **Multifunction saw:** Rotating saw blade and frame, hand protector, dual-material handle, delivered with HSS bi-metal saw blade (24 tpi)
- > **Digital measuring calliper:** LCD display, reset setting, precision roller adjustment, mm/inch changeover, ground tips, in box incl. spare battery, operating instructions, PC interface, locking screw, thread table on the back
- > **Heavy-duty utility knife:** Multi-component handle, aluminium, rapid-change mechanism, 1 trapezoid blade and 4 spare trapezoid blades, rugged design
- > **Tape measure:** ABS dual-material housing, clip, nylon-coated tape, mm-graduation, with tape rewind and lock, magnetic stop, Accuracy Class II
- > **(De)magnetizer:** Magnetizer for bolting and gripping tools, demagnetizer for tools
- > **Spirit level:** Smooth aluminium rectangular profile, two acrylic vials, measurement accuracy: +/- 0.5 mm/m, powder-coated, impact-resistant end cap
- > **Wood sectioned folding ruler:** Metric dual scale, Accuracy Class III, EC-design approval for continuous mm division, beech wood with through-riveted joints
- > **Blue pencil:** Oval form
- > **Carbide scriber:** Pencil and carbide scriber in one, straight form, retractable nib, metal housing, attaching clip
- > **LED torch:** Aluminium housing, batteries (3x AAA) supplied, loop, 2 brightness settings and additional warning/signal function, 1 W LED, 55-60 lm luminous flux, 25-30 m light range, subject to technical changes



Code	No.	Contents	W	D	pieces	
3301685	R22350004	Digital measuring calliper Heavy-duty utility knife with 4 spare blades 175 mm Tape measure 3 m (De)magnetizer Multifunction saw 300 mm Spirit level 300 mm Wood sectioned folding ruler 2 m Blue pencil 175 mm Carbide scriber 145 mm LED torch 130 mm	570	410	30	2.5

R2235 0005**SCREWDRIVER, PLIERS,
HAMMER AND CHISEL SET**

in the 3/3 foam module, 23 pieces

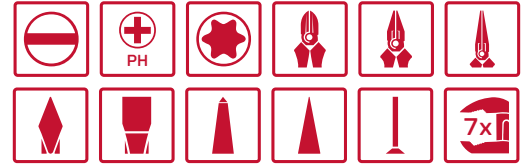

- > **Combination pliers:** To DIN ISO 5746, gripping zones for flat and round material, inductively hardened cutting edges, dual-material handle, chrome-vanadium steel
- > **Side cutters:** To DIN ISO 5749, slender head, inductively hardened, long cutting edges, dual-material handle, chrome-vanadium steel
- > **Bent nose telephone pliers, straight:** To DIN ISO 5745, straight gripping surfaces, lengthways-serrated, inductively hardened cutting edges, dual-material handle, chrome-vanadium steel
- > **Water pump pliers:** To DIN 8976 Form C, lengthways-serrated gripping surfaces, box joint, 7 settings, chrome vanadium steel, powder-coated
- > **2C screwdriver:** Slot and cross-slotted PH, to DIN, high-grade chrome-molybdenum steel blade, chrome-plated, phosphated driven tip, dual-material handle, 5-edge grip head, elongated hole in handle
- > **2C screwdriver TX:** High-grade chrome-molybdenum steel blade, chrome-plated, phosphated driven tip, dual-material handle, 5-edge grip head, elongated hole in handle
- > **Engineers' hammer:** Forged hammer head of tempered steel, inductively hardened striking surfaces, to DIN 1041, ash handle, paint-coated shaft end, ring wedge
- > **Flat chisel:** To DIN 6453, cutting edge and head ground, impact end tempered, chrome-vanadium steel
- > **Cross-cut chisel:** To DIN 6451, cutting edge, sides and head ground, impact end tempered, chrome-vanadium steel
- > **Hexagonal punch:** To DIN 6458, impact end annealed, chrome-vanadium steel
- > **Centre punch, hexagonal:** To DIN 7250, impact end annealed, chrome-vanadium steel
- > **Pin punch, octagonal:** To DIN 6450, impact end annealed, chrome-vanadium steel



Code	No.	Contents	W	D	pieces	kg
3301686	R22350005	Combination plier 180 mm Side cutter 160 mm Bent nose telephone pliers, straight 200 mm Screwdriver slotted 3 4 5.5 6.5 mm Screwdriver cross-slotted PH 1 2 Screwdriver TX T10 T15 T20 T25 T30 T40 Water pump pliers 10", 250 mm Engineers' hammer 300 g Flat cold chisel 125 mm, 150 mm Cross-cut chisel 125 mm Centre punch 4 mm 120 mm Pin punch 4 mm 120 mm Drift punch 3 mm 150 mm	570	410	23	2.8

R2235 0006

RATCHET WRENCH AND DOUBLE OPEN-ENDED SPANNER SET



in the 3/3 foam module, 22 pieces

- > **Ratchet wrenches:** Based on DN 3113, ISO 3318, straight, 72-toothed ratchet mechanism, 5° working angle, 15° jaw position, surface matt satin plate-chromed, chrome-vanadium steel
- > **Double open-ended spanner:** To DIN 3110, ISO 3318, ISO 1085, ISO 10102, 15° jaw position, surface matt satin chrome-plated, chrome-vanadium steel

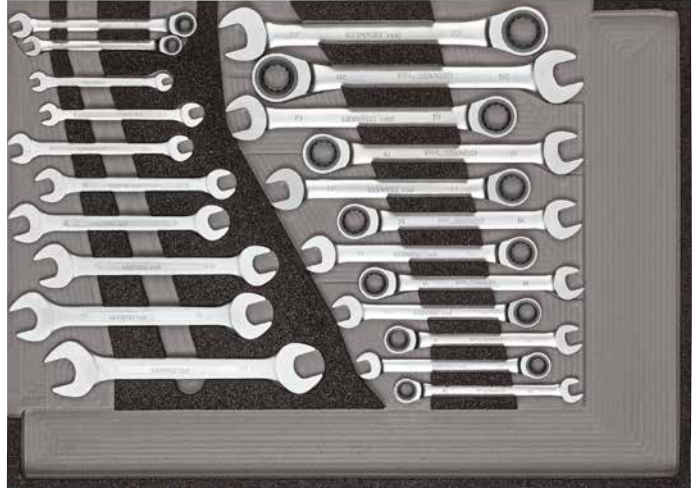

Code	No.	Contents	W	D	pieces	
3301687	R22350006	Ratchet wrench 8 9 10 11 12 13 14 15 16 17 18 19 20 22 mm Double open ended spanner 6x7 8x9 10x11 12x13 14x15 16x17 18x19 20x22 mm	570	410	22	3.4

R2215 0000

DOUBLE-ENDED RING SPANNER SET



in the 3/3 foam module, 8 pieces

- > Acc. to DIN 838, ISO 3318, ISO 1085, ISO 10104
- > 5° offset
- > Thin walled rings
- > Chrome-vanadium steel
- > Matt satin chrome-plated finish
- > In the foam module



Code	No.	Contents	W	D	pieces	
3301697	R22150000	Double-ended ring spanner 6x7 8x9 10x11 12x13 14x15 16x17 18x19 20x22 mm	157.5	310	8	1.600

R2215 0001**DOUBLE OPEN-ENDED SPANNER SET**

in the 3/3 foam module, 8 pieces



- > Acc. to DIN 3110, ISO 3318, ISO 1085, ISO 10102
- > Jaw set at 15°
- > Matt satin chrome-plated finish
- > Chrome-vanadium steel
- > In the foam module



Code	No.	Contents	W	D	pieces	kg
3301698	R22150001	Double open ended spanner 6x7 8x9 10x11 12x13 14x15 16x17 18x19 20x22 mm	157.5	310	8	0.990

R2225 0000**COMBINATION SPANNER SET
AND HEXAGON SOCKET KEY SET**

in the 3/3 foam module, 26 pieces



- > **Combination spanner:** To DIN 3113, Form A ISO 3318, ISO 7738, ring side angled 15° jaw position, surface matt satin, chrome-plated
- > **Hexagon socket key set:** To DIN ISO 2936, hardened throughout, phosphated
- > Chrome-vanadium steel
- > In the foam module



Code	No.	Contents	W	D	pieces	kg
3301699	R22250000	Combination spanner 6 7 8 9 10 11 12 13 14 15 16 17 18 19 21 22 24 mm Hexagon socket key set, 9 pcs, 1.5 2 2.5 3 4 5 6 8 10 mm	315	310	26	2.232

R2225 0001**RATCHET WRENCH AND
HEXAGON SOCKET KEY SET**

in the 3/3 foam module, 24 pieces

- > **Ratchet wrenches:** Based on DIN 3113, ISO 3318, ring offset 15°, reversible for right and left-hand operation, 15° jaw position, surface matt satin chrome-plated
- > **Hexagon socket key set:** To DIN ISO 2936, hardened throughout, phosphated
- > Chrome-vanadium steel
- > In the foam module



Code	No.	Contents	W	D	pieces	
3301700	R22250001	Ratchet wrench 8 9 10 11 12 13 14 15 16 17 18 19 20 21 22 mm Hexagon socket key set, 9 pcs, 1.5 2 2.5 3 4 5 6 8 10 mm	315	310	24	3.297

R2215 0002**RATCHET WRENCH SET**

in the 3/3 foam module, 9 pieces

- > Based on DIN 3113, ISO 3318
- > Ring offset to 15°, reversible for right and left hand operation
- > Jaw set at 15°
- > Matt satin chrome-plated finish
- > Chrome-vanadium steel
- > In the foam module



Code	No.	Contents	W	D	pieces	
3301701	R22150002	Ratchet wrench set 8 10 12 13 14 15 16 17 19 mm	157.5	310	9	1.430

R2215 0003

RATCHET WRENCH SET



in the 3/3 foam module, 10 pieces

- > Based on DIN 3113, ISO 3318
- > Straight
- > Ratchet mechanism with 72 teeth
- > Working angle: 5°
- > Jaw set at 15°
- > Matt satin chrome-plated finish
- > Chrome-vanadium steel
- > In the foam module



Code	No.	Contents	W	D	pieces	kg
3301702	R22150003	Ratchet wrench set 8 10 12 13 14 15 16 17 18 19 mm	157.5	310	10	1.680

R2215 0006

SOCKET SET 1/4"

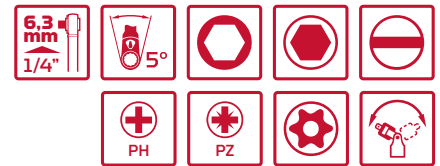

in the 3/3 foam module, 37 pieces

- > Coupler based on DIN 3120 - A 6.3, ISO 1174, with ball lock
- > Square drive as per DIN 3120 - C 6.3, ISO 1174, with ball retention groove
- > **2C reversible ratchet 1/4"**: Lever for reversible right and left hand operation, push button release, fine-toothed, oval head, dual-material handle
- > **Square plug-in handle 1/4"**: 1-component handle with in-hex
- > **Socket 1/4" hexagon**: Metric, short, to DIN 3124, ISO 2725
- > **Screwdriver bit socket 1/4" for in-hex screws**: Pressed-in, phosphated pin
- > **Screwdriver bit socket 1/4" slotted**: Pressed-in, phosphated pin
- > **Screwdriver bit socket 1/4" PZ**: Pressed-in, phosphated pin
- > **Screwdriver bit socket 1/4" PZ**: Pressed-in, phosphated pin
- > **Screwdriver bit socket 1/4" TX with drill hole**: Pressed-in, phosphated pin
- > Socket extension 1/4"
- > **Sliding T-handle with slide 1/4"**: Acc. to DIN 3122, ISO 3315
- > **Universal joint 1/4"**: Joint bolted on, design to DIN 3123 - C 6.3
- > Chrome-vanadium steel, matt satin chrome-plated
- > For hand-operated bolting operations
- > In the foam module



Code	No.	Contents	W	D	pieces	kg
3301705	R22150006	1/4" 2C lever reversible ratchet, fine-tooth, 72 teeth 150 mm 1/4" square plug-in handle 165 mm 1/4" socket hexagon 4 4.5 5 5.5 6 7 8 9 10 11 12 13 1/4" screwdriver bit socket in-hex 3 4 5 6 8 10 37 mm 1/4" screwdriver bit socket slotted 5.5 6.5 37 mm 1/4" screwdriver bit socket cross-slotted PH 1 2 3 37 mm 1/4" screwdriver bit socket cross-head PZ 1 2 37 mm 1/4" socket TX with hole T10 T15 T20 T25 T27 T30 T40 37 mm 1/4" socket extension 100 mm 1/4" sliding T-handle with slide 115 mm 1/4" universal joint 32 mm	157.5	310	37	0.870

R2215 0008 RATCHET WITH ACCESSORIES 1/2"



in the 3/3 foam module, 5 pieces

- > Coupler in acc. with DIN 3120, ISO 1174, with ball locking device
- > Square drive acc. to DIN 3120, ISO 1174, with ball retention groove
- > **2C reversible ratchet 1/2"**: To DIN 3120 - A 12.5, ISO 1174, lever for right and left-hand operation, push button release, fine-toothed, oval form, dual-material handle
- > Socket extension 1/2"
- > **Universal joint 1/2"**: Joint bolted on, design to DIN 3123 - C 12.5
- > Chrome-vanadium steel, matt satin chrome-plated
- > For hand-operated bolting operations
- > In the foam module



Code	No.	Contents	W	D	pieces	
3301707	R22150008	1/2" 2C lever reversible ratchet, fine-tooth, 72 teeth 250 mm 1/2" socket extension 125 250 mm 1/2" sliding T bar with slide 250 mm 1/2" universal joint 66 mm	157.5	310	5	1.880

R2215 0009 SOCKET SET 1/2"



in the 3/3 foam module, 26 pieces

- > Square drive acc. to DIN 3120, ISO 1174, with ball retention groove
- > **Socket, hex:** Metric, short, to DIN 3124, ISO 2725
- > **Screwdriver bit socket 1/2" for in-hex screws:** Pressed-in, phosphated pin
- > Chrome-vanadium steel, matt satin chrome-plated
- > For hand-operated bolting operations
- > In the foam module



Code	No.	Contents	W	D	pieces	
3301708	R22150009	1/2" socket hexagon 10 11 12 13 14 15 16 17 18 19 21 22 23 24 26 27 28 30 32 1/2" screwdriver bit socket in-hex 6 7 8 9 10 12 14 55 mm	157.5	310	26	1.700

R2215 0011 SCREWDRIVER BIT SOCKET SET 1/2"



in the 3/3 foam module, 15 pieces

- > Square drive acc. to DIN 3120, ISO 1174, with ball retention groove
- > **Screwdriver bit socket 1/2" for in-hex screws:** Pressed-in, phosphated pin
- > Chrome-vanadium steel, matt satin chrome-plated
- > For hand-operated bolting operations
- > In the foam module



Code	No.	Contents	W	D	pieces	
3301710	R22150011	Screwdriver bit socket in-hex, 5 6 7 8 9 10 12 14 17 55 mm Screwdriver bit socket in-hex, 5 6 8 80 mm Screwdriver bit socket in-hex, 10 12 14 140 mm	157.5	310	15	2.124

R2215 0012

IMPACT SOCKET SET 1/2"



in the 3/3 foam module, 14 pieces

- > Square drive as per DIN 3121 - G 12.5, ISO 1174
- > Acc. to DIN 3129, ISO 2725-2
- > Machine-operated, fixing with safety ring / pin
- > Surface phosphated
- > Chrome-molybdenum steel
- > In the foam module



Code	No.	Contents	W	D	pieces	
3301711	R22150012	Impact socket 10 11 12 13 14 15 16 17 19 21 22 24 78 mm Safety ring and pin (1 each)	157.5	310	14	2.840

R2215 0013

SCREWDRIVER SET



in the 3/3 foam module, 6 pieces

- > Blades of high-grade chrome-molybdenum steel, chrome-plated
- > Driven tips phosphated, corrosion-protected and low-wear
- > Moulded handles form a firm unit with the blades
- > 2 dual-material handles for a hands-friendly transfer of force
- > 5-edge handle heads stop them rolling off when put down
- > Elongated holes in the handle for hanging up
- > In the foam module



Code	No.	Contents	W	D	pieces	
3301712	R22150013	Screwdriver slotted 4 5.5 6.5 8 mm Screwdriver cross-slotted PH 12	157.5	310	6	0.854

R2215 0014

SCREWDRIVER SET



in the 3/3 foam module, 6 pieces

- > Blades of high-grade chrome-molybdenum steel, chrome-plated
- > Driven tips phosphated, corrosion-protected and low-wear
- > Moulded handles form a firm unit with the blades
- > 2 dual-material handles for a hands-friendly transfer of force
- > 5-edge handle heads stop them rolling off when put down
- > Elongated holes in the handle for hanging up
- > In the foam module



Code	No.	Contents	W	D	pieces	
3301713	R22150014	Screwdriver slotted 4 5.5 6.5 8 mm Screwdriver cross-slotted PZ 12	157.5	310	6	0.820

R2215 0015 SCREWDRIVER SET TX



in the 3/3 foam module, 6 pieces

- > Blades of high-grade chrome-molybdenum steel, chrome-plated
- > Driven tips phosphated, corrosion-protected and low-wear
- > Moulded handles form a firm unit with the blades
- > 2 dual-material handles for a hands-friendly transfer of force
- > 5-edge handle heads stop them rolling off when put down
- > Elongated holes in the handle for hanging up
- > In the foam module



Code	No.	Contents	W	D	pieces	
3301714	R22150015	Screwdriver TX T10 T15 T20 T25 T30 T40	157.5	310	6	0.800

R2215 0016 VDE SCREWDRIVER SET



in the 3/3 foam module, 6 pieces

- > **For slotted head screws:** Acc. to DIN 5264, DIN ISO 2380
- > **For cross-head screws PH:** Acc. to DIN 7438, DIN ISO 8764
- > VDE-insulated acc. to DIN EN 60900
- > Guaranteed protection for working under voltage up to 1000V AC (alternating current) and 1500V DC (direct current)
- > Blade of high-grade chrome-molybdenum steel
- > Driven tip phosphated, corrosion-protected and low-wear
- > Dual-material handle, for easy handling
- > Moulded handle forms a firm unit with the blade
- > 5-edge handle head stops it rolling off when put down
- > Elongated hole in the handle for hanging up
- > In the foam module



Code	No.	Contents	W	D	pieces	
3301715	R22150016	VDE Screwdriver slotted 2.5 3 4 5.5 mm VDE Screwdriver cross-head PH 1 2	157.5	310	6	0.680

R2215 0017 RETAINING RING PLIERS SET



in the 3/3 foam module, 4 pieces

- > To DIN 5254 Form A, straight precision tips, opening spring, DIN 471 for retaining rings, DIN 983 for shaft diameter
- > To DIN 5254 Form B, 90° angled precision tips, opening spring, DIN 471 for retaining rings, DIN 983 for shaft diameter
- > To DIN 5256 Form C, straight precision tips, opening spring, DIN 472 for retaining rings, DIN 984 for shaft diameter
- > To DIN 5256 Form D, 90° angled precision tips, DIN 472 for retaining rings, DIN 984 for drill hole diameter
- > Dipped handle protectors
- > Chrome-vanadium steel
- > In the foam module

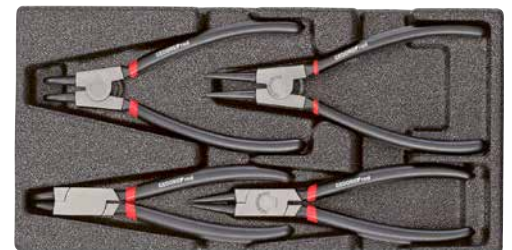

Code	No.	Contents	W	D	pieces	
3301716	R22150017	Circlip pliers for external retaining rings, straight 19-60 mm Circlip pliers for external retaining rings, angled 19-60 mm Circlip pliers for internal retaining rings, straight 19-60 mm Circlip pliers for internal retaining rings, angled 19-60 mm	157.5	310	4	1.136

R2215 0018

PLIERS SET



in the 3/3 foam module, 4 pieces

- > **Water pump pliers:** To DIN 8976 Form C, lengthways-serrated gripping surfaces, box joint, 7 settings, chrome vanadium steel, powder-coated
- > **Combination pliers:** To DIN ISO 5746, inductively hardened cutting edges, dual-material handle, forged
- > **Bent nose telephone pliers:** To DIN ISO 5745, straight gripping surfaces, lengthways-serrated, inductively hardened cutting edges, dual-material handle, forged
- > **Side cutters:** To DIN ISO 5749, slender head, inductively hardened, long cutting edges, dual-material handle, forged
- > In the foam module



GEDORE
1100

Code	No.	Contents	W	D	pieces	
3301717	R22150018	Water pump pliers 10" 250 mm Combination pliers 180 mm Bent nose telephone pliers, straight 160 mm Side cutter 160 mm	157.5	310	4	1.238

R2215 0019

HAMMER AND CHISEL SET



in the 3/3 foam module, 7 pieces

- > **Engineers' hammer:** Forged hammer head of tempered steel, inductively hardened striking surfaces, to DIN 1041, ash handle, paint-coated shaft end, ring wedge
- > **Flat cold chisel, flat oval:** To DIN 6453, cutting edge and head ground, impact end tempered, chrome-vanadium steel
- > **Cross-cut chisel, flat oval:** To DIN 6451, cutting edge, sides and head ground, impact end tempered, chrome-vanadium steel
- > **Hexagonal punch:** To DIN 6458, impact end annealed, chrome-vanadium steel
- > **Centre punch, hexagonal:** To DIN 7250, impact end annealed, chrome-vanadium steel
- > **Pin punch, octagonal:** To DIN 6450, impact end annealed, chrome-vanadium steel
- > In the foam module



Code	No.	Contents	W	D	pieces	
3301718	R22150019	Engineers' hammer 300 g Flat cold chisel 125 mm 150 mm Cross-cut chisel 125 mm Centre punch 4 mm 120 mm Pin punch 4 mm 120 mm Drift punch 3 mm 150 mm	157.5	310	7	1.222

RATCHET SPANNERS

052 - 065



Legend



Ratchet spanners

R0710XXXX COMBINATION RATCHET SPANNER



metric

- > Based on DIN 3113, ISO 3318
- > Straight
- > Jaw set at 15°
- > Matt satin chrome-plated finish
- > Chrome-vanadium steel



Code	No.	Ø mm	Overall length	Head height 1	Head height 2	Head width 1	Head width 2	∠°	Number of teeth	kg
3300828	R07100080	8	136.0	5.1	7.0	18.0	17.5	5	72	0.047
3300829	R07100090	9	143.0	5.4	7.6	20.0	19.3	5	72	0.065
3300830	R07100100	10	160.0	5.8	7.7	22.0	21.0	5	72	0.066
3300831	R07100110	11	168.0	6.1	8.3	24.5	22.7	5	72	0.077
3300832	R07100120	12	174.0	6.4	8.7	26.5	24.0	5	72	0.085
3300833	R07100130	13	180.0	6.7	9.3	27.6	26.0	5	72	0.100
3300834	R07100140	14	193.0	7.4	9.4	31.4	27.7	5	72	0.110
3300835	R07100150	15	200.0	7.7	10.0	33.4	29.0	5	72	0.149
3300836	R07100160	16	216.0	8.1	10.6	34.6	30.7	5	72	0.180
3300837	R07100170	17	233.0	8.8	10.9	38.4	33.0	5	72	0.200
3300838	R07100180	18	239.0	9.0	11.2	39.9	33.7	5	72	0.220
3300839	R07100190	19	250.0	9.5	11.5	41.5	34.8	5	72	0.248
3300840	R07100200	20	285.0	10.2	13.0	45.8	42.0	5	72	0.410
3300841	R07100210	21	285.0	10.2	13.0	45.8	42.0	5	72	0.412
3300842	R07100220	22	285.0	10.2	13.0	45.8	42.0	5	72	0.402
3300843	R07100240	24	325.0	11.0	14.5	51.5	47.5	5	72	0.504
3300844	R07100270	27	359.0	12.5	15.0	55.2	52.0	5	72	0.640
3300845	R07100300	30	425.0	13.8	17.0	65.0	60.0	5	72	1.190
3300846	R07100320	32	425.0	13.8	17.0	65.0	60.0	5	72	1.150
3300848	R07100360	36	482.0	16.6	19.6	76.2	65.5	5	72	1.757

R0710 XXXX COMBINATION RATCHET SPANNER SET



metric

- > Based on DIN 3113, ISO 3318
- > Straight
- > Ratchet mechanism with 72 teeth
- > Working angle 15°
- > Jaw set at 15°
- > Matt satin chrome-plated finish
- > Chrome-vanadium steel
- > In the holder



Code	No.	Contents	pieces	kg
3300849	R07105005	8 10 13 17 19 mm	5	0.699
3300850	R07105012	8 9 10 11 12 13 14 15 16 17 18 19 mm	12	1.569

R0720XXXX

COMBINATION RATCHET SPANNER



reversible, metric

- › Based on DIN 3113, ISO 3318
- › Ring offset to 15°, reversible for right and left hand operation
- › Jaw set at 15°
- › Matt satin chrome-plated finish
- › Chrome-vanadium steel



Code	No.	Ø mm	Overall length	Head height 1	Head height 2	Head width 1	Head width 2	°	Number of teeth	↻
3300851	R07200080	8	135	5.1	7.7	18.5	17.7	5	72	0.042
3300852	R07200090	9	142	5.3	7.7	20.5	19.1	5	72	0.070
3300853	R07200100	10	158	5.8	8.2	22.5	21.2	5	72	0.070
3300854	R07200110	11	167	5.9	8.2	25.0	22.6	5	72	0.080
3300855	R07200120	12	173	6.1	8.8	26.9	23.8	5	72	0.080
3300856	R07200130	13	179	6.6	8.9	29.0	25.9	5	72	0.101
3300857	R07200140	14	189	7.5	9.3	31.5	27.7	5	72	0.116
3300858	R07200150	15	199	7.9	9.4	34.0	29.2	5	72	0.150
3300859	R07200160	16	215	7.9	9.9	35.7	31.8	5	72	0.171
3300860	R07200170	17	232	8.0	10.6	38.3	34.1	5	72	0.197
3300861	R07200180	18	238	8.5	11.0	40.1	34.0	5	72	0.219
3300862	R07200190	19	247	8.9	11.2	42.0	35.1	5	72	0.250
3300863	R07200200	20	285	10.3	13.0	45.3	41.5	5	72	0.400
3300864	R07200210	21	285	10.3	13.0	45.3	41.5	5	72	0.401
3300865	R07200220	22	285	10.3	13.0	45.3	41.5	5	72	0.400
3300866	R07200240	24	325	10.8	14.5	52.0	47.0	5	72	0.500
3300867	R07200270	27	359	12.5	15.0	58.6	52.0	5	72	0.650
3300868	R07200300	30	425	13.0	17.0	64.5	59.5	5	72	1.140
3300869	R07200320	32	425	13.0	17.0	64.5	59.5	5	72	1.140
3300871	R07200360	36	482	15.8	19.6	75.7	65.0	5	72	1.671

R0720XXXX

COMBINATION RATCHET SPANNER SET



reversible, metric

- › Based on DIN 3113, ISO 3318
- › Ring offset to 15°, reversible for right and left hand operation
- › Ratchet mechanism with 72 teeth
- › Working angle 5°
- › Jaw set at 15°
- › Matt satin chrome-plated finish
- › Chrome-vanadium steel
- › In the holder



Code	No.	Contents	pieces	↻
3300872	R07205005	8 10 13 17 19 mm	5	0.688
3300873	R07205012	8 9 10 11 12 13 14 15 16 17 18 19 mm	12	1.576

R07203012 COMBINATION RATCHET SPANNER SET

with adapters, metric, 12 pieces

- > Based on DIN 3113, ISO 3318
- > Ring offset to 15°, reversible for right and left hand operation
- > Ratchet mechanism with 72 teeth
- > Working angle 5°
- > Jaw set at 15°
- > Matt satin chrome-plated finish
- > Chrome-vanadium steel
- > In rugged plastic case



Code	No.	Contents	pieces	kg
3300059	R07203012	Combination ratchet spanners 8 10 12 13 15 17 18 19 mm Square end drive adapter 1/4" for Size 10 mm, 3/8" for Size 13 mm, 1/2" for Size 19 mm Bit adaptor 1/4" for Size 10mm	12	15.680

R07203016 COMBINATION RATCHET SPANNER SET

with adapters, metric, 16 pieces

- > Based on DIN 3113, ISO 3318
- > Ring offset to 15°, reversible for right and left hand operation
- > Ratchet mechanism with 72 teeth
- > Working angle 5°
- > Jaw set at 15°
- > Matt satin chrome-plated finish
- > Chrome-vanadium steel
- > In rugged plastic case



Code	No.	Contents	pieces	kg
3300060	R07203016	Combination ratchet spanners 8 9 10 11 12 13 14 15 16 17 18 19 mm Square end drive adapter 1/4" for Size 10 mm, 3/8" for Size 13 mm, 1/2" for Size 19 mm Bit adaptor 1/4" for Size 10mm	16	10.000

R05905010

OPEN RATCHET SPANNER WITH FLARE RING END SET



metric, 10 pieces

- > Based on DIN 3113, ISO 3318
- > Straight
- > Open end with ratchet function
- > Jaw set at 15°
- > Ring side open, offset to 15°
- > Matt satin chrome-plated finish
- > Chrome-vanadium steel
- > In the holder



Code	No.	Contents	pieces	
3301003	R05905010	10 11 12 13 14 15 16 17 18 19 mm	10	1.758

R47001004

SQUARE DRIVE ADAPTER SET



for ratchet spanner, 4 pieces

- > For secure connection of ratchet wrench and socket
- > Push-button release
- > Square drive in acc. with DIN 3120, ISO 1174, with ball locking device
- > Bit holder with hexagon drive in acc. with DIN 3126 - C 6.3 (1/4")
- > Matt chrome-plated
- > Chrome-vanadium steel



Code	No.	Contents	pieces	
3300061	R47001004	External hex 19 mm x external sq. 1/2" for sockets External hex 13 mm x external sq. 3/8" for sockets External hex 10 mm x external sq. 1/4" for sockets External hex 10 mm x in-hex 1/4" for all 1/4" bits	4	0.100

R0730XXXX

FLEXIBLE HEAD COMBINATION RATCHET SPANNER



metric

- > Based on DIN 3113, ISO 3318
- > With 180° swivel head
- > Jaw set at 15°
- > Matt satin chrome-plated finish
- > Chrome-vanadium steel



Code	No.	Ø mm	Overall length	Head height 1	Head height 2	Head width 1	Head width 2	∠ °	Number of teeth	
3300874	R07300080	8	136	5.5	7.0	17.1	17.5	5	72	0.050
3300876	R07300100	10	160	6.1	7.7	21.3	21.0	5	72	0.080
3300879	R07300130	13	180	7.0	9.3	26.8	26.0	5	72	0.120
3300883	R07300170	17	233	8.3	10.9	37.0	32.6	5	72	0.330
3300885	R07300190	19	250	9.0	11.5	40.2	34.8	5	72	0.289
3300889	R07300240	24	325	11.5	14.5	52.3	47.9	5	72	0.560

R07305005

FLEXIBLE HEAD COMBINATION RATCHET SPANNER SET



metric, 5 pieces

- > Based on DIN 3113, ISO 3318
- > With 180° swivel head
- > Ratchet mechanism with 72 teeth
- > Working angle 5°
- > Jaw set at 15°
- > Matt satin chrome-plated finish
- > Chrome-vanadium steel
- > In the holder



Code	No.	Contents	pieces	
3300890	R07305005	8 10 13 17 19 mm	5	1.158

R0740XXXX



DOUBLE BOX RATCHET WRENCHES



straight, metric

- > Based on DIN 3113, ISO 3318
- > Straight
- > Jaw set at 15°
- > Matt satin chrome-plated finish
- > Chrome-vanadium steel



Code	No.		Overall length	Head height 1	Head height 2	Head width 1	Head width 2		Number of teeth	
3300891	R07400809	8 x 9	128.0	7.0	7.7	21.0	17.5	5	72	0.060
3300892	R07400810	8 x 10	128.0	7.0	7.7	21.0	17.5	5	72	0.060
3300893	R07401011	10 x 11	150.0	7.7	8.3	22.7	21.0	5	72	0.080
3300894	R07401213	12 x 13	170.0	8.7	9.3	26.0	24.0	5	72	0.110
3300895	R07401415	14 x 15	190.0	9.4	10.0	30.7	27.7	5	72	0.150
3300896	R07401618	16 x 18	230.0	10.6	11.2	34.8	32.6	5	72	0.200
3300897	R07401719	17 x 19	230.0	10.9	11.5	34.8	32.6	5	72	0.220

R07405006

DOUBLE BOX RATCHET WRENCH SET



straight, metric, 6 pieces

- > Based on DIN 3113, ISO 3318
- > Straight
- > Ratchet mechanism with 72 teeth
- > Working angle 5°
- > Jaw set at 15°
- > Matt satin chrome-plated finish
- > Chrome-vanadium steel
- > In the holder



Code	No.	Contents	pieces	
3300898	R07405006	8x9 10x11 12x13 14x15 16x18 17x19 mm	6	0.865

R07501002

DOUBLE BOX RATCHET WRENCH SET



reversible, metric, 2 pieces

- > 63 in 2
- > Straight
- > With lever change
- > Ratchet mechanism with 72 teeth
- > Working angle 5°
- > Matt satin chrome-plated finish
- > Chrome-vanadium steel



Code	No.	Contents	pieces	
3300900	R07501002	hex/double hex 5/16 3/8 7/16 1/2 9/16 5/8 11/16 3/4" SPLINE, hex, bi-hex 8 10 11 13 14 16 17 19 mm TX E10 E12 E14 E16 E18 E20 E22 E24 square 9/32 11/32 3/8 7/16 15/32 17/32 9/16 5/8" square 7 9 11 12 13 14 16 mm	2	0.398

R07501019

DOUBLE BOX RATCHET WRENCH



reversible, metric

- > The four most common sizes in one tool:
10, 13, 17, 19 mm
- > Straight
- > With lever change
- > Matt satin chrome-plated finish
- > Chrome-vanadium steel



Code	No.	Overall length	Head height 1	Head height 2	Head width 1	Head width 2		Number of teeth	
3300899	R07501019	210	9.8	12.2	26.5	35.6	5	72	0.210

Double ring spanner

R0110XXXX

DOUBLE RING SPANNER



metric

- > Acc. to DIN 838, ISO 3318, ISO 1085, ISO 10104
- > 5° offset
- > Thin walled rings
- > Chrome-vanadium steel
- > Matt satin chrome-plated finish



Code	No.	⌀ mm	↳ mm ↲	Head height 1	Head height 2	Head width 1	Head width 2	Offset height	kg
3300901	R01100607	6 x 7	175	5.0	5.8	10.5	11.4	19.0	0.055
3300902	R01100809	8 x 9	185	6.0	7.0	13.4	14.8	21.0	0.070
3300904	R01101011	10 x 11	198	7.4	8.4	16.4	17.9	23.0	0.090
3300906	R01101213	12 x 13	215	8.4	9.1	19.5	20.6	25.0	0.115
3300908	R01101415	14 x 15	228	9.5	10.4	22.2	23.0	25.0	0.150
3300909	R01101617	16 x 17	246	10.0	10.8	24.5	26.0	27.0	0.190
3300910	R01101719	17 x 19	268	10.8	12.1	26.4	28.4	30.0	0.235
3300911	R01101819	18 x 19	268	10.8	12.1	27.5	28.4	30.0	0.235
3300913	R01102022	20 x 22	292	11.7	12.5	30.7	33.5	31.0	0.315
3300914	R01102123	21 x 23	315	12.2	13.2	31.8	34.8	32.0	0.350
3300916	R01102426	24 x 16	328	12.2	13.4	36.3	39.6	36.0	0.450
3300917	R01102427	24 x 27	328	12.2	13.4	36.3	41.4	36.0	0.500
3300918	R01102430	24 x 30	342	13.9	14.9	37.0	43.5	36.0	0.600
3300919	R01102528	25 x 28	342	13.9	14.9	37.4	41.4	35.0	0.500
3300921	R01102732	27 x 32	365	14.0	15.8	39.9	46.3	36.0	0.600
3300922	R01103032	30 x 32	370	15.2	16.0	43.5	46.3	36.0	0.630
3300924	R01103641	36 x 41	445	17.3	18.3	52.7	60.2	42.0	1.050

R0110XXXX

DOUBLE RING SPANNER SET



metric

- > Acc. to DIN 838, ISO 3318, ISO 1085, ISO 10104
- > 5° offset
- > Thin walled rings
- > Chrome-vanadium steel
- > Matt satin chrome-plated finish
- > In the holder



Code	No.	Contents	pieces	kg
3300926	R01105008	6x7 8x9 10x11 12x13 14x15 16x17 18x19 20x22 mm	8	1.400
3300928	R01105012	6x7 8x9 10x11 12x13 14x15 16x17 18x19 20x22 21x23 24x27 25x28 30x32 mm	12	3.550

R0135XXXX

HALF-MOON RING SPANNER

metric

- > Where space is confined
- > Thin walled rings
- > Matt satin chrome-plated finish
- > Chrome-vanadium steel



Code	No.	Ø mm	l mm	Head height 1	Head height 2	Head width 1	Head width 2	Weight
3301113	R01351012	10 x 12	128	6.5	7.1	16.5	17.5	0.045
3301114	R01351113	11 x 13	150	7.4	7.6	20.1	21.7	0.075
3301115	R01351315	13 x 15	168	9.0	9.4	23.4	24.6	0.100
3301116	R01351416	14 x 16	184	9.0	9.4	23.4	26.5	0.115
3301117	R01351517	15 x 17	184	9.0	9.4	23.4	26.5	0.115

Double open-ended spanners

R0512XXXX

DOUBLE OPEN-ENDED SPANNERS

short, metric

- > Acc. to DIN 895, ISO 3318, ISO 1085
- > Jaw set at 15°
- > Chrome-vanadium steel
- > Matt satin chrome-plated finish



Code	No.	Ø mm	l mm	Head height 1	Head width 1	Head width 2	Weight
3301067	R05120607	6 x 7	97	3.2	14.4	15.4	0.017
3301068	R05120809	8 x 9	106	3.5	17.9	19.9	0.023
3301069	R05121011	10 x 11	125	5.0	22.2	24.4	0.040
3301070	R05121213	12 x 13	135	5.4	26.6	28.8	0.060
3301071	R05121415	14 x 15	150	5.8	31.0	33.2	0.083
3301072	R05121617	16 x 17	160	6.0	33.5	37.7	0.095
3301073	R05121819	18 x 19	176	6.6	37.7	42.0	0.130
3301074	R05122022	20 x 22	196	7.2	41.3	46.9	0.190
3301075	R05122123	21 x 23	212	7.7	46.0	50.0	0.235
3301076	R05122426	24 x 26	245	8.0	50.5	56.0	0.288
3301077	R05122427	24 x 27	245	8.0	50.5	56.0	0.288
3301078	R05122528	25 x 28	245	8.0	50.5	56.0	0.283
3301079	R05122732	27 x 32	259	9.3	58.0	63.5	0.400
3301080	R05123032	30 x 32	259	9.3	58.0	63.5	0.400

R05126008

DOUBLE OPEN-ENDED SPANNER IN WALLET

metric, 8 pieces

- > Acc. to DIN 895, ISO 3318, ISO 1085
- > Jaw set at 15°
- > Chrome-vanadium steel
- > Matt satin chrome-plated finish
- > In practical roll-cover



Code	No.	Contents	pieces	Weight
3301081	R05126008	6x7 8x9 10x11 12x13 14x15 16x17 18x19 20x22 mm	8	0.640

R0512XXXX

DOUBLE OPEN-ENDED SPANNER SET



short, metric

- > Acc. to DIN 895, ISO 3318, ISO 1085
- > Jaw set at 15°
- > Chrome-vanadium steel
- > Matt satin chrome-plated finish
- > In the holder



Code	No.	Contents	pieces	
3300958	R05125006	6x7 8x9 10x11 12x13 14x15 16x17 mm	6	0.300
3300961	R05125012	6x7 8x9 10x11 12x13 14x15 16x17 18x19 20x22 21x23 24x26 25x28 27x32 mm	12	2.000

R0510XXXX

DOUBLE OPEN-ENDED SPANNERS



long, metric

- > Acc. to DIN 3110, ISO 3318, ISO 1085, ISO 10102
- > Jaw set at 15°
- > Matt satin chrome-plated finish
- > Chrome-vanadium steel



Code	No.	Ø mm	↳ mm ↲	Head height 1	Head width 1	Head width 2	
3300930	R05100607	6 x 7	122	3.4	17.6	18.6	0.025
3300931	R05100809	8 x 9	140	3.8	21.1	23.1	0.040
3300933	R05101011	10 x 11	157	4.6	24.6	27.6	0.040
3300934	R05101013	10 x 13	172	5.1	24.6	31.6	0.060
3300935	R05101213	12 x 13	172	5.1	29.1	32.6	0.055
3300940	R05101415	14 x 15	188	5.6	32.8	35.8	0.100
3300942	R05101617	16 x 17	205	6.1	36.8	40.3	0.110
3300943	R05101719	17 x 19	222	6.6	40.3	44.3	0.155
3300944	R05101819	18 x 19	222	6.6	40.3	44.3	0.155
3300946	R05102022	20 x 22	236	7.1	44.8	49.8	0.210
3300947	R05102123	21 x 23	247	7.6	47.3	51.3	0.240
3300948	R05102224	22 x 24	247	7.6	47.3	51.3	0.240
3300949	R05102426	24 x 26	266	8.1	54.8	61.3	0.300
3300950	R05102427	24 x 27	266	8.1	54.8	61.3	0.300
3300952	R05102528	25 x 28	280	8.6	56.3	61.3	0.460
3300954	R05102732	27 x 32	302	9.1	61.3	64.8	0.460
3300955	R05103032	30 x 32	302	9.1	64.8	69.3	0.460
3300957	R05103641	36 x 41	360	10.3	77.3	85.8	0.830

R0510 XXXX

DOUBLE OPEN-ENDED SPANNER SET



long, metric

- > Acc. to DIN 3110, ISO 3318, ISO 1085, ISO 10102
- > Jaw set at 15°
- > Matt satin chrome-plated finish
- > Chrome-vanadium steel
- > In the holder



Code	No.	Contents	pieces	
3300959	R05105008	6x7 8x9 10x11 12x13 14x15 16x17 18x19 20x22 mm	8	0.700
3300960	R05105012	6x7 8x9 10x11 12x13 14x15 16x17 18x19 20x22 21x23 24x27 25x28 30x32 mm	12	2.150

Combination spanners

R0910 XXXX

COMBINATION SPANNERS



metric

- > Acc. to DIN 3113, Form A, ISO 3318, ISO 7738
- > Ring offset to 15°
- > Jaw set at 15°
- > Matt satin chrome-plated finish
- > Chrome-vanadium steel



Code	No.			Head height 1	Head height 2	Head width 1	Head width 2	
3300962	R09100060	6	95	5.2	3.7	9.8	13.3	0.016
3300963	R09100070	7	105	5.7	3.7	11.4	15.5	0.021
3300964	R09100080	8	110	6.2	4.2	13.0	17.7	0.025
3300965	R09100090	9	120	6.7	4.2	14.5	20.0	0.031
3300966	R09100100	10	130	7.2	4.7	16.0	22.2	0.035
3300967	R09100110	11	140	7.0	5.0	17.5	24.4	0.035
3300968	R09100120	12	153	8.0	5.5	19.0	26.6	0.050
3300969	R09100130	13	163	8.5	5.5	20.3	28.8	0.065
3300970	R09100140	14	173	9.0	5.8	22.0	31.0	0.075
3300971	R09100150	15	185	9.5	6.0	23.0	33.2	0.090
3300972	R09100160	16	198	10.0	6.5	24.5	35.5	0.105
3300973	R09100170	17	210	10.5	7.0	26.0	37.6	0.120
3300974	R09100180	18	220	11.0	7.4	27.5	39.9	0.155
3300975	R09100190	19	230	11.2	7.5	29.0	42.1	0.170
3300976	R09100200	20	240	12.0	8.2	31.0	44.2	0.200
3300977	R09100210	21	252	12.0	8.2	32.5	46.5	0.240
3300978	R09100220	22	262	12.7	8.6	34.0	48.6	0.260
3300980	R09100240	24	282	13.6	9.0	37.0	53.2	0.300
3300983	R09100270	27	310	14.6	9.5	41.0	59.8	0.400
3300986	R09100300	30	340	16.1	10.6	45.0	63.6	0.500
3300987	R09100320	32	360	17.3	11.6	48.0	67.5	0.700

R0910 XXXX COMBINATION SPANNER SET



metric

- > Acc. to DIN 3113, Form A, ISO 3318, ISO 7738
- > Ring offset to 15°
- > Jaw set at 15°
- > Matt satin chrome-plated finish
- > Chrome-vanadium steel
- > In the holder



Code	No.	Contents	pieces	kg
3300988	R09105008	8 9 10 11 13 14 17 19 mm	8	0.600
3300989	R09105010	8 10 11 12 13 14 15 17 19 22 mm	10	0.850
3300990	R09105012	10 11 12 13 14 17 19 22 24 27 30 32 mm	12	2.500
3300992	R09105112	6 7 8 9 10 11 12 13 14 17 19 22 mm	12	1.100
3300993	R09105015	6 7 8 10 11 12 13 14 17 19 22 24 27 30 32 mm	15	3.100
3300994	R09105017	6 7 8 9 10 11 12 13 14 15 16 17 18 19 20 21 22 mm	17	1.800
3300991	R09105021	6 7 8 9 10 11 12 13 14 15 16 17 18 19 20 21 22 24 27 30 32 mm	21	3.325
3300995	R09105024	6 7 8 9 10 11 12 13 14 15 16 17 18 19 20 21 22 23 24 26 27 28 30 32 mm	24	5.400

R0911 XXXX COMBINATION SPANNERS



INCH (AF)

- > Ring offset to 15°
- > Jaw set at 15°
- > Chrome-vanadium steel
- > Matt satin chrome-plated finish



Code	No.	AF	mm	Head height 1	Head height 2	Head width 1	Head width 2	kg
3301026	R09110016	1/4	95	5.2	3.7	9.8	13.3	0.020
3301027	R09110020	5/16	110	6.2	4.2	13.0	17.7	0.020
3301028	R09110024	3/8	130	7.2	4.7	16.0	22.2	0.030
3301029	R09110028	7/16	140	7.5	5.0	17.5	24.4	0.045
3301030	R09110032	1/2	163	8.5	5.5	20.3	28.8	0.070
3301031	R09110036	9/16	173	9.0	5.8	22.0	31.0	0.085
3301032	R09110040	5/8	198	10.0	6.5	24.5	35.5	0.095
3301033	R09110044	11/16	210	10.5	7.0	26.0	37.6	0.150
3301034	R09110048	3/4	230	11.2	7.5	29.0	42.1	0.180
3301035	R09110052	13/16	252	12.0	8.2	32.5	46.5	0.206
3301036	R09110056	7/8	262	12.7	8.6	34.0	48.6	0.254
3301037	R09110060	15/16	282	13.6	9.0	37.0	53.2	0.295
3301038	R09110064	1	302	14.5	9.5	38.5	57.6	0.373
3301039	R09110068	1.1/16	310	14.6	9.5	41.0	59.8	0.375
3301040	R09110072	1.1/8	320	16.0	10.5	42.0	62.0	0.435
3301041	R09110080	1.1/4	360	17.3	11.6	48.0	67.5	0.634

R0911 5016

COMBINATION SPANNER SET

INCH (AF) 16 pieces

- > Ring offset to 15°
- > Jaw set at 15°
- > Chrome-vanadium steel
- > Matt satin chrome-plated finish
- > In the holder



Code	No.	Contents	pieces	
3301043	R09115016	1/4 5/16 3/8 7/16 1/2 9/16 5/8 11/16 3/4 13/16 7/8 15/16 1 1.1/16 1.1/8 1.1/4"	16	3.800

Various

R0310 XXXX

ADJUSTABLE SPANNERS

- > Acc. to DIN 3117, Form A
- > Jaw set at 15°
- > Polished head with lasered scale
- > High torque
- > 40-50 HRC
- > Chrome-vanadium steel
- > Chrome-plated



Code	No.	↳ "inch" ↳	↳ mm ↳	"inch"	mm	
3300996	R03100006	6	150	0.94	24	0.140
3300997	R03100008	8	200	1.18	30	0.250
3300998	R03100010	10	250	1.34	34	0.420
3300999	R03100012	12	300	1.6	41	0.700

R0380 XXXX

ADJUSTABLE SPANNERS

- > Acc. to DIN 3117, Form A
- > Jaw set at 15°
- > Swedish pattern, roller with left hand thread
- > With mm-scale
- > Chrome-vanadium steel
- > Phosphated
- > With hole for hanging up



Code	No.	↳ "inch" ↳	↳ mm ↳	"inch"	mm	
3301064	R03800015	15	385	1.69	43	1.400
3301065	R03800018	18	460	2.17	55	2.100
3301066	R03800024	24	610	2.44	62	3.700

R0391 XXXX

ADJUSTABLE SPANNERS



with ratchet

- > Jaw set at 15°
- > Swedish pattern, roller with left hand thread
- > Ratchet function
- > With mm-scale
- > 40 HRC
- > Chrome-vanadium steel
- > Chrome-plated
- > Dip-coated handle covers
- > With hole for hanging up



Code	No.	↳ "inch" ↳	↳ mm ↳	"inch"	mm	kg
3301001	R03910008	8	205	1.18	30	0.366
3301002	R03910010	10	256	1.42	36	0.584

R0170 0057

WHEEL WRENCH

- > Chrome-vanadium steel
- > Chrome-plated



Code	No.	mm	↳ mm ↳	kg
3301453	R01700057	17 x 19 (3/4") x 21 x 11/16"	360	1.250

RANGE OF SOCKETS

066 - 089



Legend



1/4" drive

Ratchets 1/4" drive

R40000027 2C REVERSIBLE RATCHET 1/4"



- > Lever for reversible clockwise/anticlockwise operation
- > Push-button release
- > Fine-toothed
- > Oval head
- > Dual-material handle, for easy handling
- > Matt chrome-plated surface
- > For sockets, accessories etc. with square drive as per DIN 3120 - C 6.3, ISO 1174, with ball retention groove
- > Chrome-vanadium steel



Code	No.	"	■	mm	°	Number of teeth	kg
3300158	R40000027	1/4	6.3	150	5	72	0.122

R40050009 2C REVERSIBLE RATCHET 1/4"



offset

- > Offset design for in-depth screw work
- > Lever for reversible clockwise/anticlockwise operation
- > Push-button release
- > Sturdy mechanisms
- > Oval head
- > Dual-material handle, for easy handling
- > Matt chrome-plated surface
- > For sockets, accessories etc. with square drive as per DIN 3120 - C 6.3, ISO 1174, with ball retention groove
- > Chrome-vanadium steel



Code	No.	"	■	mm	°	Number of teeth	kg
3300159	R40050009	1/4	6.3	145	10	36	0.100

R40120027

2C SWIVEL HEAD REVERSIBLE RATCHET 1/4"



- > Ratchet head swivels through 180°
- > Lockable in 5 positions
- > Lever for reversible clockwise/anticlockwise operation
- > Push-button release
- > Matt chrome-plated surface
- > Fine-toothed
- > Oval head
- > Dual-material handle, for easy handling
- > For sockets, accessories etc. with square drive as per DIN 3120 - C 6.3, ISO 1174, with ball retention groove
- > Chrome-vanadium steel



Code	No.	□"	■	↳ mm ↳	↙°	Number of teeth	⚖
3300156	R40120027	1/4	6.3	163	5	72	0.130

R40170027

2C SWIVEL HEAD BIT RATCHET 1/4"



reversible

- > Ratchet head swivels through 180°
- > Lockable in 5 positions
- > Magnetic holder
- > Lever for reversible clockwise/anticlockwise operation
- > In-hex for direct mounting of bits as per DIN 3126 - D 6.3
- > Matt chrome-plated surface
- > Fine-toothed
- > Oval head
- > Dual-material handle, for easy handling
- > Chrome-vanadium steel



Code	No.	○"	○	↳ mm ↳	↙°	Number of teeth	⚖
3300160	R40170027	1/4	6.3	163	5	72	0.130

R40150027

BIT RATCHET 1/4"



reversible, with drive adapter

- > Lever for reversible clockwise/anticlockwise operation
- > Fine-toothed
- > Oval head
- > In-hex for direct mounting of bits as per DIN 3126 - D 6.3
- > Retention spring
- > Sturdy all-steel design
- > Matt chrome-plated surface
- > Driving adapter hex x sq.
- > Coupler based on DIN 3120 - A 6.3, ISO 1174, with ball lock
- > External hex drive as per DIN 3126 - C 6.3 (1/4"), with ball lock
- > Chrome-vanadium steel



Code	No.	○"	○	↳ mm ↳	↙°	Number of teeth	pieces	⚖
3300161	R40150027	1/4	6.3	91	6	60	2	0.034

Sockets 1/4"

R4100XXXX
SOCKET 1/4"

hexagon, metric, short

- > Hand-operated, knurled grip
- > Drive end matt chrome-plated, driven end bright-polished
- > Acc. to DIN 3124, ISO 2725
- > Square drive as per DIN 3120 - C 6.3, ISO 1174, with ball retention groove
- > Chrome-vanadium steel



Code	No.	Ø mm	□"	□	↳ mm ↲	Ø 1	Ø 2	g/kg
3300064	R41000403	4.0	1/4	6.3	25	6.7	12.0	0.012
3300065	R41004503	4.5	1/4	6.3	25	7.2	12.0	0.013
3300066	R41000503	5.0	1/4	6.3	25	7.8	12.0	0.013
3300067	R41005503	5.5	1/4	6.3	25	8.5	12.0	0.013
3300068	R41000603	6.0	1/4	6.3	25	9.1	12.0	0.014
3300069	R41000703	7.0	1/4	6.3	25	10.5	12.0	0.012
3300070	R41000803	8.0	1/4	6.3	25	11.3	12.0	0.014
3300071	R41000903	9.0	1/4	6.3	25	12.0	13.0	0.012
3300072	R41001003	10.0	1/4	6.3	25	12.7	14.5	0.014
3300073	R41001103	11.0	1/4	6.3	25	14.0	16.0	0.017
3300074	R41001203	12.0	1/4	6.3	25	15.0	17.0	0.020
3300075	R41001303	13.0	1/4	6.3	25	16.0	18.0	0.020
3300076	R41001403	14.0	1/4	6.3	25	18.0	19.7	0.180

R4100XXXX
SOCKET 1/4"

hexagon, metric, long

- > Hand-operated, knurled grip
- > Drive end matt chrome-plated, driven end bright-polished
- > Acc. to DIN 3124, ISO 2725
- > Square drive as per DIN 3120 - C 6.3, ISO 1174, with ball retention groove
- > Chrome-vanadium steel



Code	No.	Ø mm	□"	□	↳ mm ↲	Ø 1	Ø 2	g/kg
3300077	R41000409	4.0	1/4	6.3	50	6.7	12.0	0.028
3300078	R41004509	4.5	1/4	6.3	50	7.2	12.0	0.026
3300079	R41000509	5.0	1/4	6.3	50	7.8	12.0	0.030
3300080	R41005509	5.5	1/4	6.3	50	8.5	12.0	0.030
3300081	R41000609	6.0	1/4	6.3	50	9.1	12.0	0.029
3300082	R41000709	7.0	1/4	6.3	50	10.5	12.0	0.025
3300083	R41000809	8.0	1/4	6.3	50	11.3	12.0	0.024
3300084	R41000909	9.0	1/4	6.3	50	12.0	13.2	0.032
3300085	R41001009	10.0	1/4	6.3	50	12.7	14.7	0.039
3300086	R41001109	11.0	1/4	6.3	50	14.0	16.0	0.050
3300087	R41001209	12.0	1/4	6.3	50	15.0	17.0	0.055
3300088	R41001309	13.0	1/4	6.3	50	16.0	18.0	0.055

R4120XXXX

SOCKET 1/4"



for external TX screws

- › Hand-operated, knurled grip
- › Drive end matt chrome-plated, driven end bright-polished
- › Square drive as per DIN 3120 - C 6.3, ISO 1174, with ball retention groove
- › Chrome-vanadium steel



Code	No.	⊕	□"	□	↳ mm ↲	Ø 1	Ø 2	⚖
3300102	R41200203	E5	1/4	6.3	25	7.2	12.0	0.013
3300103	R41200303	E6	1/4	6.3	25	8.2	12.0	0.014
3300104	R41200403	E7	1/4	6.3	25	9.0	12.0	0.014
3300105	R41200503	E8	1/4	6.3	25	13.3	12.0	0.015
3300106	R41200703	E10	1/4	6.3	25	12.5	13.2	0.015

R4255XXXX

SCREWDRIVER BIT SOCKET 1/4"



for in-hex screws

- › Pressed-in phosphated pin
- › Hand-operated, knurled grip
- › Drive end brightly polished
- › Acc. to DIN 7422
- › Square drive as per DIN 3120 - C 6.3, ISO 1174, with ball retention groove
- › Chrome-vanadium steel



Code	No.	⊙ mm	□"	□	↳ mm ↲	Tip length	Ø 1	⚖
3300123	R42550306	3	1/4	6.3	37	15	12	0.016
3300124	R42550406	4	1/4	6.3	37	15	12	0.016
3300125	R42550506	5	1/4	6.3	37	15	12	0.017
3300126	R42550606	6	1/4	6.3	37	15	12	0.017
3300127	R42550806	8	1/4	6.3	37	15	12	0.020
3300128	R42551006	10	1/4	6.3	37	15	12	0.020

R4245XXXX

SCREWDRIVER BIT SOCKET 1/4"



for recessed TX screws

- › Pressed-in phosphated pin
- › Hand-operated, knurled grip
- › Drive end brightly polished
- › Square drive as per DIN 3120 - C 6.3, ISO 1174, with ball retention groove
- › Chrome-vanadium steel



Code	No.	⊕	□"	□	↳ mm ↲	Tip length	Ø 1	⚖
3300107	R42451106	T10	1/4	6.3	37	15	12	0.015
3300108	R42451206	T15	1/4	6.3	37	15	12	0.016
3300109	R42451306	T20	1/4	6.3	37	15	12	0.016
3300110	R42451406	T25	1/4	6.3	37	15	12	0.016
3300111	R42451506	T27	1/4	6.3	37	15	12	0.016
3300112	R42451606	T30	1/4	6.3	37	15	12	0.016
3300113	R42451806	T40	1/4	6.3	37	15	12	0.017

R4246XXXX

SCREWDRIVER BIT SOCKET 1/4"



for recessed TX head screws with shaft

- > Pressed-in phosphated pin
- > Hand-operated, knurled grip
- > Drive end brightly polished
- > Square drive as per DIN 3120 - C 6.3, ISO 1174, with ball retention groove
- > Chrome-vanadium steel



Code	No.		"	□	↳ mm ◀	Tip length	Ø 1	
3300116	R42461106	T10	1/4	6.3	37	15	12	0.015
3300117	R42461206	T15	1/4	6.3	37	15	12	0.016
3300118	R42461306	T20	1/4	6.3	37	15	12	0.016
3300119	R42461406	T25	1/4	6.3	37	15	12	0.016
3300120	R42461506	T27	1/4	6.3	37	15	12	0.016
3300121	R42461606	T30	1/4	6.3	37	15	12	0.016

Accessories 1/4" drive

R45200022

SLIDING T-BAR WITH SLIDER 1/4"



- > Acc. to DIN 3122, ISO 3315
- > Matt chrome-plated
- > For hand-operated sockets
- > Coupler based on DIN 3120 - A 6.3, ISO 1174, with ball lock
- > Chrome-vanadium steel



Code	No.	■ "	■	↳ mm ◀	
3300143	R45200022	1/4	6.3	115	0.038

R38950001

SQUARE PLUG-IN HANDLE 1/4"



- > For hand-operated sockets with square drive as per DIN 3120, ISO 1174, with ball locking device
- > Dual-material handle, for easy handling
- > Matt chrome-plated
- > Coupler in acc. with DIN 3120 - A 6.3, ISO 1174, with ball locking device
- > Internal square in the handle suitable for ratchet-performed drive as per DIN 3120 - C 6.3, ISO 1174, with ball retaining groove
- > Chrome-vanadium steel



Code	No.	■ "	■	↳ mm ◀	↳ mm ◀	Ø	
3301344	R38950001	1/4	6.3	61	171	8	0.120

R4510XXX SOCKET EXTENSION 1/4"

6.3mm
1/4"

- > Matt chrome-plated
- > For hand-operated sockets
- > Square drive as per DIN 3120 - C 6.3, ISO 1174, with ball retention groove
- > Coupler based on DIN 3120 - A 6.3, ISO 1174, with ball lock
- > Chrome-vanadium steel



Code	No.	■ "	■	↳ mm ↳	⚖
3300140	R45100009	1/4	6.3	50	0.025
3300141	R45100019	1/4	6.3	100	0.050
3300142	R45100029	1/4	6.3	150	0.065

R4530 0005 UNIVERSAL JOINT 1/4"

6.3mm
1/4"

- > Screwed-on joint
- > Acc. to DIN 3123 - C 6.3
- > Matt chrome-plated
- > For hand-operated sockets
- > Square drive as per DIN 3120 - C 6.3, ISO 1174, with ball retention groove
- > Coupler based on DIN 3120 - A 6.3, ISO 1174, with ball lock
- > Chrome-vanadium steel



Code	No.	■ "	■	□ "	□	↳ mm ↳	⚖
3300144	R45300005	1/4	6.3	1/4	6.3	33	0.024

R47001004 SQUARE DRIVE ADAPTER SET

6.3mm 10mm 12.5mm
1/4" 3/8" 1/2"

for ratchet spanner, 4 pieces

- > For secure connection of ratchet wrench and socket
- > Push-button release
- > Square drive in acc. with DIN 3120, ISO 1174, with ball locking device
- > Bit holder with hexagon drive in acc. with DIN 3126 - C 6.3 (1/4")
- > Matt chrome-plated
- > Chrome-vanadium steel



Code	No.	Contents	pieces	⚖
3300061	R47001004	External hex 19 mm x external sq. 1/2" for sockets External hex 13 mm x external sq. 3/8" for sockets External hex 10 mm x external sq. 1/4" for sockets External hex 10 mm x in-hex 1/4" for all 1/4" bits	4	0.100

R4710 XXXX

SOCKET HOLDER 1/4"

6,3mm
1/4"

- > Matt satin chrome-plated finish
- > Square drive as per DIN 3120 - C 6.3, ISO 1174, with ball retention groove
- > For 1/4" bits with hexagon drive as per DIN 3126, ISO 1173
- > Chrome-vanadium steel
- > Retention spring



Code	No.	□"	□	□"	□	↳ mm	↳ kg
3300151	R47100103	1/4	6.3	1/4	6.3	25	0.018

R3895 0000

BIT SCREWDRIVER 1/4"

6,3mm
1/4"



- > Dual-material handle, for easy handling
- > Hex recess drive as per DIN 3126 - D 6.3 (1/4"), for bits
- > Bit holder with powerful magnet
- > Elongated hole in handle for hanging up
- > Chrome-vanadium steel



Code	No.	□"	□	↳ mm	↳ mm	↳ kg
3301343	R38950000	1/4	6.3	100	210	0.110

R4711 0009

DRIVE ADAPTER 1/4"

6,3mm
1/4"

- > For driving sockets and screwdriver bit sockets
- > Coupler based on DIN 3120 - A 6.3, ISO 1174, with ball lock
- > Hex drive as per DIN 3126 - C 6.3 (1/4") for use in chucks
- > Sand-blasted



Code	No.	□"	□	□"	□	↳ mm	↳ kg
3300150	R47110009	1/4	6.3	1/4	6.3	50	0.016

R4710 0003

DRIVE ADAPTER 1/4"



- > For driving sockets and screwdriver bit sockets
- > Coupler based on DIN 3120 - A 6.3, ISO 1174, with ball lock
- > Hexagon drive as per DIN 3126 - C 6.3 (1/4")
- > Sand-blasted



Code	No.	1/4"	6.3	1/4"	6.3	mm	g
3300149	R47100003	1/4	6.3	1/4	6.3	25	0.008

R4712 0011

QUICK-CHANGE BIT HOLDER 1/4"



with magnet

- > Quick-grip system for hex bits as per DIN 3126 - C 6.3 + E 6.3 (1/4")
- > Hex drive as per DIN 3126 - C 6.3 (1/4") for use in chucks
- > Release for bit ejection



Code	No.	1/4"	6.3	1/4"	6.3	mm	g
3300148	R47120011	1/4	6.3	1/4	6.3	60	0.030

R4711 XXXX

BIT HOLDER



with magnet

- > Acc. to DIN 7427
- > For hex bits as per DIN 3126 - C 6.3 + E 6.3 (1/4"), hex drive as per DIN 3126 - C 6.3 (1/4") for use in chucks



Code	No.	1/4"	6.3	1/4"	6.3	mm	g
3300146	R47110011	1/4	6.3	1/4	6.3	60	0.022
3300147	R47110014	1/4	6.3	1/4	6.3	75	0.030

R4711 XXXX

SOCKET



1/4" hexagon, with magnet

- > For hex bits as per DIN 3126 - C 6.3 + E 6.3 (1/4")
- > Sand-blasted



Code	No.	AF	1/4"	6.3	mm	g
3300517	R47110012	1/4	1/4	6.3	65	0.026
3300518	R47110112	5/16	1/4	6.3	65	0.030
3300519	R47110212	3/8	1/4	6.3	65	0.036

3/8" drive

Ratchets 3/8"

R50000027

2C REVERSIBLE RATCHET 3/8"



- > Lever for reversible clockwise/anticlockwise operation
- > Push-button release
- > Fine-toothed
- > Oval head
- > Dual-material handle, for easy handling
- > Matt chrome-plated surface
- > For sockets, accessories etc. with square drive as per DIN 3120 - C 10, ISO 1174, with ball retention groove
- > Chrome-vanadium steel



Code	No.	"	■	↳ mm ↳	°	Number of teeth	kg
3300224	R50000027	3/8	10	180	5	72	0.282

R50050009

2C REVERSIBLE RATCHET 3/8"

offset



- > Offset design for in-depth screw work
- > Lever for reversible clockwise/anticlockwise operation
- > Push-button release
- > Sturdy mechanisms
- > Oval head
- > Dual-material handle, for easy handling
- > Matt chrome-plated surface
- > For sockets, accessories etc. with square drive as per DIN 3120 - C 10, ISO 1174, with ball retention groove
- > Chrome-vanadium steel



Code	No.	"	■	↳ mm ↳	°	Number of teeth	kg
3300225	R50050009	3/8	10	210	10	36	0.226

R50120027

2C SWIVEL HEAD REVERSIBLE RATCHET 3/8"



- > Ratchet head swivels through 180°
- > Lockable in 5 positions
- > Lever for reversible clockwise/anticlockwise operation
- > Push-button release
- > Matt chrome-plated surface
- > Oval head
- > Dual-material handle, for easy handling
- > For sockets, accessories etc. with square drive as per DIN 3120 - C 10, ISO 1174, with ball retention groove
- > Chrome-vanadium steel



Code	No.	"	■	↳ mm ↳	°	Number of teeth	kg
3301819	R50120027	3/8	10	246	5	72	0.339

Sockets 3/8"

R5100 XXXX

SOCKET 3/8"

hexagon, metric, short



- > Hand-operated, knurled grip
- > Drive end matt chrome-plated, driven end bright-polished
- > Acc. to DIN 3124, ISO 2725
- > Square drive as per DIN 3120 - C 10, ISO 1174, with ball retention groove
- > Chrome-vanadium steel



Code	No.	□"	□	⊙mm	↳mm↵	∅1	∅2	±
3300164	R51000604	3/8	10	6	28	10.0	17.0	0.019
3300165	R51000704	3/8	10	7	28	10.6	17.0	0.019
3300166	R51000804	3/8	10	8	28	11.8	17.0	0.020
3300167	R51000904	3/8	10	9	28	13.2	17.0	0.021
3300168	R51001004	3/8	10	10	28	14.2	17.0	0.021
3300169	R51001104	3/8	10	11	28	15.6	17.0	0.021
3300170	R51001204	3/8	10	12	28	17.0	18.0	0.024
3300171	R51001304	3/8	10	13	28	18.0	17.0	0.029
3300172	R51001404	3/8	10	14	28	19.5	19.0	0.032
3300173	R51001504	3/8	10	15	28	21.0	20.0	0.036
3300174	R51001604	3/8	10	16	28	22.0	21.0	0.039
3300175	R51001704	3/8	10	17	30	23.5	22.0	0.053
3300176	R51001804	3/8	10	18	30	24.5	23.0	0.057
3300177	R51001904	3/8	10	19	30	26.0	24.0	0.061
3300178	R51002004	3/8	10	20	32	28.0	25.0	0.074
3300179	R51002104	3/8	10	21	32	28.0	26.0	0.074
3300180	R51002204	3/8	10	22	32	30.0	28.0	0.088

Accessories 3/8" drive

R5520 0039

SLIDING T-BAR WITH SLIDER 3/8"



- > Acc. to DIN 3122, ISO 3315
- > Matt chrome-plated
- > For hand-operated sockets
- > Coupler based on DIN 3120 - A 10, ISO 1174, with ball lock
- > Chrome-vanadium steel



Code	No.	□"	□	↳mm↵	±
3300242	R55200039	3/8	10	200	0.190

R5510XXXX

SOCKET EXTENSION 3/8"

- > Matt chrome-plated
- > For hand-operated sockets
- > Square drive as per DIN 3120 - C 10, ISO 1174, with ball retention groove
- > Coupler based on DIN 3120 - A 10, ISO 1174, with ball lock
- > Chrome-vanadium steel



Code	No.	□"	□	■"	■	↳ mm ↳	⚖
3300218	R55100024	3/8	10	3/8	10	125	0.100
3300219	R55100029	3/8	10	3/8	10	150	0.150

R5730 0005

SOCKET EXTENSION PIECE 3/8" TO 1/2"

- > Matt chrome-plated
- > For hand-operated sockets
- > Square drive as per DIN 3120 - C 10, ISO 1174, with ball retention groove
- > Coupler based on DIN 3120 - A 12.5, ISO 1174, with ball lock
- > Chrome-vanadium steel
- > Additional socket extension turns the convertor into a sliding T-bar with slider



Code	No.	□"	□	■"	■	↳ mm ↳	⚖
3300243	R57300008	3/8	10	1/2	12.5	44	0.068

R5750 0004

REDUCER 3/8" TO 1/4"

- > Matt chrome-plated
- > For hand-operated sockets
- > Square drive as per DIN 3120 - C 10, ISO 1174, with ball retention groove
- > Coupler based on DIN 3120 - A 6.3, ISO 1174, with ball lock
- > Chrome-vanadium steel



Code	No.	□"	□	■"	■	↳ mm ↳	⚖
3300244	R57500004	3/8	10	1/4	6.3	27	0.021

1/2" square drive

Ratchets 1/2"

R60000027
2C REVERSIBLE RATCHET 1/2"



- > Lever for reversible clockwise/anticlockwise operation
- > Push-button release
- > Fine-toothed
- > Oval head
- > Dual-material handle, for easy handling
- > Matt chrome-plated surface
- > For sockets, accessories etc. with square drive as per DIN 3120 - C 12.5, ISO 1174, with ball retention groove
- > Chrome-vanadium steel



Code	No.	"	mm	mm	°	Number of teeth	mm
3300410	R60000027	1/2	12.5	250	5	72	0.586

R60050009
2C REVERSIBLE RATCHET 1/2"



offset

- > Offset design for in-depth screw work
- > Lever for reversible clockwise/anticlockwise operation
- > Push-button release
- > Sturdy mechanisms
- > Oval head
- > Dual-material handle, for easy handling
- > Matt chrome-plated surface
- > For sockets, accessories etc. with square drive as per DIN 3120 - C 12.5, ISO 1174, with ball retention groove
- > Chrome-vanadium steel



Code	No.	"	mm	mm	°	Number of teeth	mm
3300411	R60050009	1/2	12.5	255	10	36	0.514

R60120027
2C SWIVEL HEAD REVERSIBLE RATCHET 1/2"



- > Ratchet head swivels through 180°
- > Lockable in 5 positions
- > Lever for reversible clockwise/anticlockwise operation
- > Push-button release
- > Matt chrome-plated surface
- > Fine-toothed
- > Oval head
- > Dual-material handle, for easy handling
- > For sockets, accessories etc. with square drive as per DIN 3120 - C 12.5, ISO 1174, with ball retention groove
- > Chrome-vanadium steel



Code	No.	"	mm	mm	°	Number of teeth	mm
3300409	R60120027	1/2	12.5	292	5	72	0.633

R6060006

2C RATCHET HANDLE WITH COUPLER 1/2"



- > Square coupler for clockwise/anti-clockwise operation
- > Sturdy mechanisms
- > Acc. to DIN 3122, ISO 3315
- > Dual-material handle, for easy handling
- > Matt chrome-plated surface
- > Also suitable for use with stepped keys and radiator nipple keys
- > For sockets, accessories etc. with square drive as per DIN 3120 - C 12.5, ISO 1174, with ball retention groove
- > Chrome-vanadium steel



Code	No.	"	mm	mm	°	Number of teeth	kg
3300412	R6060006	1/2	12.5	270	12	30	0.560

R60110009

2C SWIVEL-HEAD TELESCOPIC RATCHET

reversible



- > Telescopic shaft lockable in 5 positions
- > Ratchet head swivels through 180°
- > Ring for reversing clockwise/anticlockwise direction
- > Sturdy mechanisms
- > Dual-material handle, for easy handling
- > Matt chrome-plated surface
- > For sockets, accessories etc. with square drive as per DIN 3120 - C 12.5, ISO 1174, with ball retention groove
- > Chrome-vanadium steel
- > Hole for hanging up

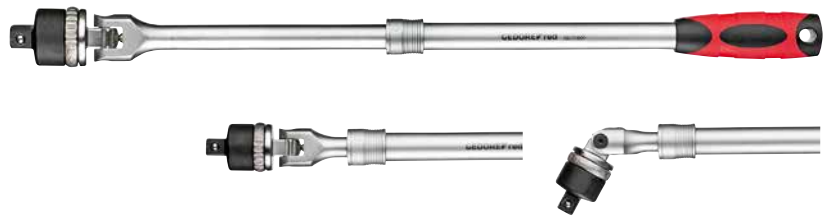

Code	No.	"	mm	mm	°	Number of teeth	kg
3300523	R60110009	1/2	12.5	430-580	10	36	1.292

R60010027

2C TELESCOPIC RATCHET

reversible



- > Lever for reversible clockwise/anticlockwise operation
- > Push-button release
- > Telescopic shaft lockable in 5 positions
- > Dual-material handle, for easy handling
- > Matt chrome-plated surface
- > For sockets, accessories etc. with square drive as per DIN 3120 - C 12.5, ISO 1174, with ball retention groove
- > Chrome-vanadium steel
- > Hole for hanging up



Code	No.	"	mm	mm	°	Number of teeth	kg
3300522	R60010027	1/2	12.5	460-600	5	72	1.099

Sockets 1/2"

R6100XXXX

SOCKET 1/2"

hexagon, metric, short



- › Hand-operated, knurled grip
- › Drive end matt chrome-plated, driven end bright-polished
- › Acc. to DIN 3124, ISO 2725
- › Square drive as per DIN 3120 - C 12.5, ISO 1174, with ball retention groove
- › Chrome-vanadium steel

Code	No.	□"	□	⊙ mm	↳ mm ↲	∅ 1	∅ 2	
3300257	R61000806	1/2	12.5	8	38	12.4	22.2	0.050
3300258	R61000906	1/2	12.5	9	38	14.2	22.2	0.050
3300259	R61001006	1/2	12.5	10	38	15.3	22.2	0.050
3300260	R61001106	1/2	12.5	11	38	16.5	22.2	0.051
3300261	R61001206	1/2	12.5	12	38	17.8	22.2	0.052
3300262	R61001306	1/2	12.5	13	38	19.0	22.2	0.052
3300263	R61001406	1/2	12.5	14	38	20.2	22.2	0.054
3300264	R61001506	1/2	12.5	15	38	21.3	22.2	0.054
3300265	R61001606	1/2	12.5	16	38	23.2	22.2	0.060
3300266	R61001706	1/2	12.5	17	38	24.2	23.0	0.063
3300267	R61001806	1/2	12.5	18	38	25.0	23.0	0.066
3300268	R61001906	1/2	12.5	19	38	27.0	24.0	0.080
3300269	R61002006	1/2	12.5	20	38	28.0	24.0	0.077
3300270	R61002106	1/2	12.5	21	38	29.0	24.0	0.091
3300271	R61002206	1/2	12.5	22	38	30.0	26.0	0.092
3300272	R61002306	1/2	12.5	23	38	31.0	28.0	0.102
3300273	R61002406	1/2	12.5	24	38	32.0	28.0	0.105
3300274	R61002507	1/2	12.5	25	42	34.0	28.0	0.147
3300275	R61002607	1/2	12.5	26	42	35.0	29.0	0.150
3300276	R61002707	1/2	12.5	27	42	36.0	30.0	0.175
3300277	R61002807	1/2	12.5	28	42	37.0	30.0	0.200
3300278	R61003007	1/2	12.5	30	42	40.0	34.0	0.219
3300279	R61003207	1/2	12.5	32	42	42.0	36.0	0.192

R6100XXXX

SOCKET 1/2"

hexagon, metric, long



- › Hand-operated, knurled grip
- › Drive end matt chrome-plated, driven end bright-polished
- › Acc. to DIN 3124, ISO 2725
- › Square drive as per DIN 3120 - C 12.5, ISO 1174, with ball retention groove
- › Chrome-vanadium steel

Code	No.	□"	□	⊙ mm	↳ mm ↲	∅ 1	∅ 2	
3300304	R61001014	1/2	12.5	10	77	15.3	22.2	0.073
3300305	R61001114	1/2	12.5	11	77	16.5	22.2	0.080
3300306	R61001214	1/2	12.5	12	77	17.8	22.2	0.090
3300307	R61001314	1/2	12.5	13	77	19.0	22.2	0.096
3300308	R61001414	1/2	12.5	14	77	20.2	22.2	0.100
3300309	R61001514	1/2	12.5	15	77	21.3	22.2	0.110
3300310	R61001614	1/2	12.5	16	77	23.2	22.2	0.114
3300311	R61001714	1/2	12.5	17	77	24.2	23.0	0.126
3300312	R61001814	1/2	12.5	18	77	25.0	23.0	0.131
3300313	R61001914	1/2	12.5	19	77	27.0	24.0	0.161
3300314	R61002014	1/2	12.5	20	77	28.0	24.0	0.167
3300315	R61002114	1/2	12.5	21	77	29.0	24.0	0.192
3300316	R61002214	1/2	12.5	22	77	30.0	26.0	0.192
3300318	R61002414	1/2	12.5	24	77	32.0	28.0	0.214
3300319	R61002714	1/2	12.5	27	77	36.0	30.0	0.310
3300320	R61003014	1/2	12.5	30	77	40.0	34.0	0.355
3300321	R61003214	1/2	12.5	32	77	42.0	36.0	0.408

R6110XXXX

SOCKET 1/2"



bi-hex, metric, short

- > Hand-operated, knurled grip
- > Drive end matt chrome-plated, driven end bright-polished
- > Acc. to DIN 3124, ISO 2725
- > Square drive as per DIN 3120 - C 12.5, ISO 1174, with ball retention groove
- > Chrome-vanadium steel



Code	No.	□"	□	⌀ mm	↳ mm ↲	Ø 1	Ø 2	⚖
3300323	R61100806	1/2	12.5	8	38	12.4	22.2	0.050
3300324	R61100906	1/2	12.5	9	38	14.2	22.2	0.050
3300325	R61101006	1/2	12.5	10	38	15.3	22.2	0.050
3300326	R61101106	1/2	12.5	11	38	16.5	22.2	0.051
3300327	R61101206	1/2	12.5	12	38	17.8	22.2	0.052
3300328	R61101306	1/2	12.5	13	38	19.0	22.2	0.052
3300329	R61101406	1/2	12.5	14	38	20.2	22.2	0.054
3300330	R61101506	1/2	12.5	15	38	21.3	22.2	0.054
3300331	R61101606	1/2	12.5	16	38	23.2	22.2	0.060
3300332	R61101706	1/2	12.5	17	38	24.2	23.0	0.063
3300333	R61101806	1/2	12.5	18	38	25.0	23.0	0.066
3300334	R61101906	1/2	12.5	19	38	27.0	24.0	0.080
3300335	R61102006	1/2	12.5	20	38	28.0	24.0	0.077
3300336	R61102106	1/2	12.5	21	38	29.0	24.0	0.091
3300337	R61102206	1/2	12.5	22	38	30.0	26.0	0.092
3300338	R61102306	1/2	12.5	23	38	31.0	28.0	0.102
3300339	R61102406	1/2	12.5	24	38	32.0	28.0	0.105
3300341	R61102607	1/2	12.5	26	42	35.0	29.0	0.147
3300342	R61102707	1/2	12.5	27	42	36.0	30.0	0.150
3300343	R61102807	1/2	12.5	28	42	37.0	30.0	0.175
3300345	R61103007	1/2	12.5	30	42	40.0	34.0	0.200
3300346	R61103207	1/2	12.5	32	42	42.0	36.0	0.219

R6110XXXX

SOCKET 1/2"



bi-hex, metric, long

- > Hand-operated, knurled grip
- > Drive end matt chrome-plated, driven end bright-polished
- > Acc. to DIN 3124, ISO 2725
- > Square drive as per DIN 3120 - C 12.5, ISO 1174, with ball retention groove
- > Chrome-vanadium steel



Code	No.	□"	□	⌀ mm	↳ mm ↲	Ø 1	Ø 2	⚖
3300413	R61101014	1/2	12.5	10	77	15.3	22.2	0.073
3300414	R61101114	1/2	12.5	11	77	16.5	22.2	0.080
3300415	R61101214	1/2	12.5	12	77	17.8	22.2	0.090
3300416	R61101314	1/2	12.5	13	77	19.0	22.2	0.096
3300417	R61101414	1/2	12.5	14	77	20.2	22.2	0.100
3300418	R61101514	1/2	12.5	15	77	21.3	22.2	0.110
3300419	R61101614	1/2	12.5	16	77	23.2	22.2	0.114
3300420	R61101714	1/2	12.5	17	77	24.2	23.0	0.126
3300421	R61101814	1/2	12.5	18	77	25.0	23.0	0.131
3300422	R61101914	1/2	12.5	19	77	27.0	24.0	0.161
3300423	R61102014	1/2	12.5	20	77	28.0	24.0	0.167
3300424	R61102114	1/2	12.5	21	77	29.0	24.0	0.192
3300425	R61102214	1/2	12.5	22	77	30.0	26.0	0.192
3300426	R61102414	1/2	12.5	24	77	32.0	28.0	0.214
3300427	R61102714	1/2	12.5	27	77	36.0	30.0	0.310
3300428	R61103014	1/2	12.5	30	77	40.0	34.0	0.355
3300429	R61103214	1/2	12.5	32	77	42.0	36.0	0.408

R6120XXX

SOCKET 1/2"



for external TX screws

- > Hand-operated, knurled grip
- > Drive end matt chrome-plated, driven end bright-polished
- > Square drive as per DIN 3120 - C 12.5, ISO 1174, with ball retention groove
- > Chrome-vanadium steel



Code	No.	□"	□	⊗	↳ mm ↲	Ø 1	Ø 2	⚖
3300348	R61200506	1/2	12.5	E8	38	11.1	22.0	0.045
3300349	R61200706	1/2	12.5	E10	38	13.1	22.0	0.052
3300350	R61200806	1/2	12.5	E11	38	13.8	22.0	0.054
3300351	R61200906	1/2	12.5	E12	38	14.9	22.0	0.052
3300352	R61201106	1/2	12.5	E14	38	16.7	22.0	0.052
3300353	R61201306	1/2	12.5	E16	38	18.7	22.0	0.056
3300354	R61201506	1/2	12.5	E18	38	20.3	22.0	0.054
3300355	R61201706	1/2	12.5	E20	38	22.3	24.0	0.062
3300356	R61201807	1/2	12.5	E22	40	24.3	26.0	0.078
3300357	R61201907	1/2	12.5	E24	41	26.3	28.0	0.094

R61021612

SPARK PLUG SOCKET 1/2"



- > Hand-operated, knurled grip
- > Drive end matt chrome-plated, driven end bright-polished
- > Rubber insert for holding the spark plug
- > Acc. to DIN 3124, ISO 2725
- > Square drive as per DIN 3120 - C 12.5, ISO 1174, with ball retention groove
- > Chrome-vanadium steel



Code	No.	□"	□	⊗ mm	↳ mm ↲	Ø 1	⚖
3300401	R61021612	1/2	12.5	16.0	65	21.7	0.090

R61022112

SPARK PLUG SOCKET 1/2"



Square drive

- > Hex drive 23 mm
- > Hand-operated, knurled grip
- > Drive end matt chrome-plated, driven end bright-polished
- > Rubber insert for holding the spark plug
- > Acc. to DIN 3124, ISO 2725
- > Square drive as per DIN 3120 - C 12.5, ISO 1174, with ball retention groove
- > Chrome-vanadium steel



Code	No.	□"	□	⊗ mm	↳ mm ↲	Ø 1	⚖
3300402	R61022112	1/2	12.5	21.0	65	27.7	0.138

R6255 XXXX

SCREWDRIVER BIT SOCKET 1/2"



hexagon, metric, short

- > Pressed-in phosphated pin
- > Hand-operated, knurled grip
- > Drive end brightly polished
- > Acc. to DIN 7422
- > Square drive as per DIN 3120 - C 12.5, ISO 1174, with ball retention groove
- > Chrome-vanadium steel



Code	No.	⌀ mm	□ "	□	↳ mm ◁	Tip length	Ø 1	kg
3300358	R62550410	4	1/2	12.5	55	17	22	0.060
3300359	R62550510	5	1/2	12.5	55	17	22	0.064
3300360	R62550610	6	1/2	12.5	55	17	22	0.064
3300361	R62550710	7	1/2	12.5	55	17	22	0.068
3300362	R62550810	8	1/2	12.5	55	17	22	0.068
3300363	R62550910	9	1/2	12.5	55	17	22	0.078
3300364	R62551010	10	1/2	12.5	55	17	22	0.080
3300365	R62551110	11	1/2	12.5	55	17	24	0.112
3300366	R62551210	12	1/2	12.5	55	17	24	0.112
3300367	R62551410	14	1/2	12.5	55	17	24	0.136
3300368	R62551710	17	1/2	12.5	55	17	26	0.174
3300369	R62551910	19	1/2	12.5	55	17	28	0.220

R6255 XXXX

SCREWDRIVER BIT SOCKET 1/2"



hexagon, metric, long

- > Pressed-in phosphated pin
- > Hand-operated, knurled grip
- > Drive end brightly polished
- > Acc. to DIN 7422
- > Square drive as per DIN 3120 - C 12.5, ISO 1174, with ball retention groove
- > Chrome-vanadium steel



Code	No.	⌀ mm	□ "	□	↳ mm ◁	Tip length	Ø 1	kg
3300377	R62550519	5	1/2	12.5	100	62	22	0.070
3300378	R62550619	6	1/2	12.5	100	62	22	0.075
3300379	R62550719	7	1/2	12.5	100	62	22	0.084
3300380	R62550819	8	1/2	12.5	100	62	22	0.090
3300381	R62551019	10	1/2	12.5	100	62	22	0.150
3300382	R62551219	12	1/2	12.5	100	62	24	0.190
3300383	R62551419	14	1/2	12.5	100	62	24	0.220
3300384	R62551719	17	1/2	12.5	100	62	26	0.228

R6245XXXX SCREWDRIVER BIT SOCKET 1/2"



for recessed TX screws

- › Pressed-in phosphated pin
- › Hand-operated, knurled grip
- › Drive end brightly polished
- › Square drive as per DIN 3120 - C 12.5, ISO 1174, with ball retention groove
- › Chrome-vanadium steel



Code	No.		□"	□	↳ mm ◀	Tip length	Ø 1	
3300391	R62451310	T20	1/2	12.5	55	17	22	0.058
3300392	R62451410	T25	1/2	12.5	55	17	22	0.058
3300393	R62451510	T27	1/2	12.5	55	17	22	0.059
3300394	R62451610	T30	1/2	12.5	55	17	22	0.059
3300395	R62451810	T40	1/2	12.5	55	17	22	0.063
3300396	R62451910	T45	1/2	12.5	55	17	22	0.064
3300397	R62452110	T50	1/2	12.5	55	17	22	0.065
3300398	R62452210	T55	1/2	12.5	55	17	22	0.074
3300399	R62452310	T60	1/2	12.5	55	17	24	0.100

R6245XXXX SCREWDRIVER BIT SOCKET 1/2"



for recessed TX head screws, long

- › Pressed-in phosphated pin
- › Hand-operated, knurled grip
- › Drive end brightly polished
- › Square drive as per DIN 3120 - C 12.5, ISO 1174, with ball retention groove
- › Chrome-vanadium steel



Code	No.		□"	□	↳ mm ◀	Tip length	Ø 1	
3300450	R62451319	T20	1/2	12.5	100	62	22	0.080
3300451	R62451419	T25	1/2	12.5	100	62	22	0.085
3300452	R62451519	T27	1/2	12.5	100	62	22	0.085
3300453	R62451619	T30	1/2	12.5	100	62	22	0.085
3300454	R62451819	T40	1/2	12.5	100	62	22	0.085
3300455	R62451919	T45	1/2	12.5	100	62	22	0.090
3300456	R62452119	T50	1/2	12.5	100	62	22	0.120
3300457	R62452219	T55	1/2	12.5	100	62	22	0.155
3300458	R62452319	T60	1/2	12.5	100	62	24	0.155

R6270XXXX SCREWDRIVER BIT SOCKET 1/2"



for multi-point screws XZN, long

- › Pressed-in phosphated pin
- › Hand-operated, knurled grip
- › Drive end brightly polished
- › Square drive as per DIN 3120 - C 12.5, ISO 1174, with ball retention groove
- › Chrome-vanadium steel



Code	No.		□"	□	↳ mm ◀	Tip length	Ø 1	
3300471	R62700519	M5	1/2	12.5	100	62	22	0.070
3300472	R62700619	M6	1/2	12.5	100	62	22	0.075
3300473	R62700819	M8	1/2	12.5	100	62	22	0.090
3300474	R62701019	M10	1/2	12.5	100	62	22	0.150
3300475	R62701219	M12	1/2	12.5	100	62	24	0.190
3300476	R62701419	M14	1/2	12.5	100	62	24	0.170
3300477	R62701619	M16	1/2	12.5	100	62	26	0.190

Accessories 1/2" drive

R6520 0049

SLIDING T-BAR WITH SLIDER 1/2"



- > Acc. to DIN 3122, ISO 3315
- > Matt chrome-plated
- > For hand-operated sockets
- > Coupler based on DIN 3120 - A 12.5, ISO 1174, with ball lock
- > Chrome-vanadium steel



Code	No.	■ "	■	↳ mm ↳	⚖ kg
3300408	R65200049	1/2	12.5	250	0.368

R6510 XXXX

SOCKET EXTENSION 1/2"



- > Matt chrome-plated
- > For hand-operated sockets
- > Square drive as per DIN 3120 - C 12.5, ISO 1174, with ball retention groove
- > Coupler based on DIN 3120 - A 12.5, ISO 1174, with ball lock
- > Chrome-vanadium steel



Code	No.	■ "	■	↳ mm ↳	⚖ kg
3300403	R65100014	1/2	12.5	75	0.100
3300404	R65100024	1/2	12.5	125	0.180
3300406	R65100049	1/2	12.5	250	0.430

R6530 0012

UNIVERSAL JOINT 1/2"



- > Screwed-on joint
- > Acc. to DIN 3123 - C 12.5
- > Matt chrome-plated
- > For hand-operated sockets
- > Square drive as per DIN 3120 - C 12.5, ISO 1174, with ball retention groove
- > Coupler based on DIN 3120 - A 12.5, ISO 1174, with ball lock
- > Chrome-vanadium steel



Code	No.	■ "	■	□ "	□	↳ mm ↳	⚖ kg
3300407	R65300012	1/2	12.5	1/2	12.5	66.0	0.140

R67131002 ADAPTER AND EXTENSION SET 6IN2

2 pieces

- > Push-through type square for dual-side use
- > Converter and extension
- > Reducer and extension
- > Matt chrome-plated
- > Knurled grip
- > For hand-operated sockets
- > Square drive as per DIN 3120, ISO 1174, with ball retention groove
- > Coupler in acc. with DIN 3120, ISO 1174, with ball locking device



Code	No.	Contents	
3300524	R67131002	Reducer and convertor 1/2" - 3/8" and 3/8" - 1/2" Extension 65 mm Reducer and convertor 3/8" - 1/4" and 1/4" - 3/8" Extension 50 mm	0.240

R6730 0009 SOCKET EXTENSION PIECE 1/2" X 3/4"

square

- > Matt chrome-plated
- > For hand-operated sockets
- > Square drive as per DIN 3120 - C 12.5, ISO 1174, with ball retention groove
- > Coupler as per DIN 3120 - B 20, ISO 1174, with locking pin
- > Chrome-vanadium steel



Code	No.	"	"	"	"	"	
3300449	R67300009	1/2	12.5	3/4	20	49	0.187

R6750 0007 REDUCER 1/2" X 3/8"

square

- > Matt chrome-plated
- > For hand-operated sockets
- > Square drive as per DIN 3120 - C 12.5, ISO 1174, with ball retention groove
- > Coupler based on DIN 3120 - A 10, ISO 1174, with ball lock
- > Chrome-vanadium steel



Code	No.	"	"	"	"	"	
3300430	R67500007	1/2	12.5	3/8	10	40	0.050

R6710 0006 BIT ADAPTER 1/2"

- > Matt chrome-plated
- > For hand-operated sockets
- > Square drive as per DIN 3120 - C 12.5, ISO 1174, with ball retention groove
- > Hex recess drive as per DIN 3126 - D 8 (5/16"), for bits
- > Clamping ring
- > Chrome-vanadium steel



Code	No.	"	"	"	"	"	
3300521	R67100006	1/2	12.5	5/16	8.0	38	0.056

3/4" square drive

Ratchets 3/4"

R7000 0003 REVERSIBLE RATCHET 3/4"



- > Lever for reversible clockwise/anticlockwise operation
- > Sturdy with knurled grip
- > Acc. to DIN 3122, ISO 3315
- > Oval head
- > Matt chrome-plated surface
- > For sockets, accessories etc. with square drive as per DIN 3120 - D 20, ISO 1174, with locking pin
- > Chrome-vanadium steel



Code	No.	□"	□	↳ mm	°	Number of teeth	kg
3300514	R70000003	3/4	20	503	15	24	1.940

Sockets 3/4"

R7100 XXXX SOCKET 3/4"



hex, metric

- > Hand-operated, knurled grip
- > Drive end matt chrome-plated, driven end bright-polished
- > Acc. to DIN 3124, ISO 2725
- > Square drive as per DIN 3120 - D 20, ISO 1174, with drill hole for locking pin
- > Chrome-vanadium steel



Code	No.	□"	□	○ mm	Ø 1	Ø 2	↳ mm	kg
3300491	R71001909	3/4	20	19	29	36	50	0.160
3300492	R71002109	3/4	20	21	31	36	50	0.210
3300493	R71002209	3/4	20	22	32	36	50	0.210
3300494	R71002409	3/4	20	24	34	36	51	0.220
3300495	R71002709	3/4	20	27	38	36	52	0.210
3300496	R71002809	3/4	20	28	40	36	52	0.258
3300497	R71003010	3/4	20	30	42	36	54	0.250
3300498	R71003210	3/4	20	32	44	36	56	0.260
3300499	R71003310	3/4	20	33	46	36	56	0.280
3300500	R71003410	3/4	20	34	46	36	56	0.290
3300501	R71003611	3/4	20	36	50	45	58	0.350
3300502	R71003811	3/4	20	38	52	45	60	0.460
3300503	R71004112	3/4	20	41	56	45	64	0.550
3300504	R71004613	3/4	20	46	62	45	68	0.600
3300505	R71005013	3/4	20	50	68	45	72	0.810
3300506	R71005514	3/4	20	55	74	45	76	0.930
3300507	R71006014	3/4	20	60	80	45	78	1.114

Accessories 3/4" drive

R7520 0091

SLIDING T-BAR WITH SLIDER 3/4"

20mm
3/4"

- > Acc. to DIN 3122, ISO 3315
- > Matt chrome-plated
- > For hand-operated sockets
- > Coupler as per DIN 3120 - D 20, ISO 1174, with locking pin
- > Chrome-vanadium steel



Code	No.	■"	■	◀ mm ▶	⚖
3300513	R75200091	3/4	20	458	1.164

R7510XXXX

SOCKET EXTENSION 3/4"

20mm
3/4"

- > Matt chrome-plated
- > For hand-operated sockets
- > Square drive as per DIN 3120 - D 20, ISO 1174, with drill hole for locking pin
- > Coupler as per DIN 3120 - B 20, ISO 1174, with locking pin
- > Chrome-vanadium steel



Code	No.	■"	■	◀ mm ▶	⚖
3300509	R75100039	3/4	20	200	0.640
3300510	R75100079	3/4	20	400	1.054

R7530 0021

UNIVERSAL JOINT 3/4"

20mm
3/4"

- > Screwed-on joint
- > Acc. to DIN 3123 - C 20
- > Matt chrome-plated
- > For hand-operated sockets
- > Square drive as per DIN 3120 - D 20, ISO 1174, with drill hole for locking pin
- > Coupler as per DIN 3120 - B 20, ISO 1174, with locking pin
- > Chrome-vanadium steel



Code	No.	■"	■	□"	□	◀ mm ▶	⚖
3300512	R75300021	3/4	20	3/4	20	107	0.584

R77300011

SOCKET EXTENSION PIECE 3/4" - 1"



- > Matt chrome-plated
- > For hand-operated sockets
- > Square drive as per DIN 3120 - D 20, ISO 1174, with drill hole for locking pin
- > Coupler as per DIN 3120 - B 25, ISO 1174, with locking pin
- > Chrome-vanadium steel



Code	No.	□"	□	■"	■	↳ mm ↳	⚖
3300511	R77300011	3/4	20	1	25	58	0.326

R87500012

REDUCER 1" X 3/4"



- > Matt chrome-plated
- > For hand-operated sockets
- > Square drive as per DIN 3120 - D 25, ISO 1174, with drill hole for locking pin
- > Coupler as per DIN 3120 - B 20, ISO 1174, with locking pin
- > Chrome-vanadium steel



Code	No.	□"	□	■"	■	↳ mm ↳	⚖
3300516	R87500012	1	25	3/4	20	69	0.400

R77500009

REDUCER 3/4" X 1/2"



- > Matt chrome-plated
- > For hand-operated sockets
- > Square drive as per DIN 3120 - D 20, ISO 1174, with drill hole for locking pin
- > Coupler based on DIN 3120 - A 12.5, ISO 1174, with ball lock
- > Chrome-vanadium steel



Code	No.	□"	□	■"	■	↳ mm ↳	⚖
3300515	R77500009	3/4	20	1/2	12.5	55	0.140

SOCKET SETS

090-123



1/4" square drive

R4900 4033
SOCKET SET 1/4"

32 pieces

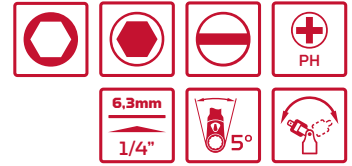

- > Coupler based on DIN 3120 - A 6.3, ISO 1174, with ball lock
- > Square drive as per DIN 3120 - C 6.3, ISO 1174, with ball retention groove
- > **2C reversible ratchet 1/4" dopsleutel 1/4"; 6-kant:** metrisch lever for reversing clockwise/anticlockwise direction, push-button release, fine-toothed, oval head, dual-material handle for ease in handling, for sockets
- > **Square plug-in handle 1/4":** 1-component handle with female square
- > **Socket 1/4", hex:** metric, short, as per DIN 3124, ISO 2725
- > **Screwdriver bit socket 1/4", for hex screws:** with pressed-in, phosphated pin
- > **Screwdriver bit socket 1/4", slotted:** with pressed-in, phosphated pin
- > **Screwdriver bit socket 1/4" PH:** with pressed-in, phosphated pin
- > Socket extension 1/4"
- > **Sliding T-bar with slider 1/4":** as per DIN 3122, ISO 3315
- > **Universal joint 1/4":** screwed-on joint, acc. to DIN 3123 - C 6.3
- > **Adapter 1/4":** for driving sockets and sockets
- > Chrome-vanadium steel, matt satin chrome-plated
- > For hand-operated screw work
- > Red sheet-steel case with foam insert



Code	No.	Contents	L	W	D	pieces	kg
3300000	R49004033	1/4" 2C lever reversible ratchet, fine-toothed, 72 teeth 150 mm 1/4" square plug-in handle 165 mm 1/4" socket hexagon 4 4.5 5 5.5 6 7 8 9 10 11 12 13 25 mm 1/4" screwdriver bit socket in-hex 3 4 5 6 8 10 37 mm 1/4" screwdriver bit socket slotted 4 5.5 6.5 37 mm 1/4" screwdriver bit socket cross-head PH 0 1 2 3 37 mm 1/4" socket extension 50 100 mm 1/4" sliding T-bar with slider 115 mm 1/4" universal joint 32 mm Drive adapter 1/4" hex x 1/4" sq. 50 mm	318	147	46	32	1.140

R49014033

SOCKET SET 1/4"



32 pieces

- > Coupler based on DIN 3120 - A 6.3, ISO 1174, with ball lock
- > Square drive as per DIN 3120 - C 6.3, ISO 1174, with ball retention groove
- > **2C reversible ratchet 1/4"**: lever for reversing clockwise/anticlockwise direction, push-button release, fine-toothed, oval head, dual-material handle for ease in handling, for sockets
- > **Square plug-in handle 1/4"**: 1-component handle with female square
- > **Socket 1/4", hex**: metric, short, as per DIN 3124, ISO 2725
- > **Screwdriver bit socket 1/4", for hex screws**: with pressed-in, phosphated pin
- > **Screwdriver bit socket 1/4" TX**: with pressed-in, phosphated pin
- > Socket extension 1/4"
- > **Sliding T-bar with slider 1/4"**: as per DIN 3122, ISO 3315
- > **Universal joint 1/4"**: screwed-on joint, acc. to DIN 3123 - C 6.3
- > **Adapter 1/4"**: for driving sockets and sockets
- > Chrome-vanadium steel, matt satin chrome-plated
- > For hand-operated screw work
- > Red sheet-steel case with foam insert



Code	No.	Contents	L	W	D	pieces	📏
3300001	R49014033	1/4" 2C lever reversible ratchet, fine-toothed, 72 teeth 150 mm 1/4" square plug-in handle 165 mm 1/4" socket hexagon 4 4.5 5 5.5 6 7 8 9 10 11 12 13 25 mm 1/4" screwdriver bit socket in-hex 3 4 5 6 8 10 37 mm 1/4" screwdriver bit socket TX T10 T15 T20 T25 T27 T30 T40 37 mm 1/4" socket extension 50 100 mm 1/4" sliding T bar with slider 115 mm 1/4" universal joint 32 mm Drive adapter 1/4" hex x 1/4" sq. 50 mm	318	147	46	32	1.136

R49044033

SOCKET SET 1/4"



33 pieces

- > Coupler based on DIN 3120 - A 6.3, ISO 1174, with ball lock
- > Square drive as per DIN 3120 - C 6.3, ISO 1174, with ball retention groove
- > **2C swivel-head reversible ratchet 1/4"**: lever for reversing clockwise/anticlockwise direction, push-button release, fine-toothed, oval head, dual-material handle for ease in handling, for sockets
- > **Square plug-in handle 1/4"**: 1-component handle with female square
- > **Socket 1/4", hex**: metric, short, as per DIN 3124, ISO 2725
- > **Screwdriver bit socket 1/4", for hex screws**: with pressed-in, phosphated pin
- > **Screwdriver bit socket 1/4" TX**: with drill hole, with pressed-in, phosphated pin
- > Socket extension 1/4"
- > **Sliding T-bar with slider 1/4"**: as per DIN 3122, ISO 3315
- > **Universal joint 1/4"**: screwed-on joint, acc. to DIN 3123 - C 6.3
- > **Adapter 1/4"**: for driving sockets and sockets
- > **Bit adaptor 1/4"**: with in-hex and female square, for all bits and tools with 1/4" external hex
- > Chrome-vanadium steel, matt satin chrome-plated
- > For hand-operated screw work
- > Red sheet-steel case with foam insert



Code	No.	Contents	L	W	D	pieces	📏
3300004	R49044033	1/4" 2C swivel head reversible ratchet, fine-toothed, 72 teeth 150 mm 1/4" square plug-in handle 165 mm 1/4" socket hexagon 4 4.5 5 5.5 6 7 8 9 10 11 12 13 25 mm 1/4" screwdriver bit socket in-hex 3 4 5 6 8 10 37 mm 1/4" socket TX with hole T10 T15 T20 T25 T27 T30 T40 37 mm 1/4" socket extension 50 100 mm 1/4" sliding T bar with slider 115 mm 1/4" universal joint 32 mm Drive adapter 1/4" hex x 1/4" sq. 50 mm Bit adaptor 1/4" sq. x 1/4" hex 25 mm	318	147	46	33	1.164

R49003016

SOCKET SET 1/4"



16 pieces

- > Coupler based on DIN 3120 - A 6.3, ISO 1174, with ball lock
- > Square drive as per DIN 3120 - C 6.3, ISO 1174, with ball retention groove
- > **2C reversible ratchet 1/4"**: lever for reversing clockwise/anticlockwise direction, push-button release, fine-toothed, oval head, dual-material handle for ease in handling, for sockets
- > **Socket 1/4", hex**: metric, short, as per DIN 3124, ISO 2725
- > Socket extension 1/4"
- > **Sliding T-bar with slider 1/4"**: as per DIN 3122, ISO 3315
- > **Bit adaptor 1/4"**: with in-hex and female square, for all bits and tools with 1/4" external hex
- > Chrome-vanadium steel, matt satin chrome-plated
- > For hand-operated screw work
- > Plastic case in GEDORE red Design
- > Clamp-secured tools
- > Metal hinges/fastener



Code	No.	Contents	L	W	D	pieces	kg
3300050	R49003016	1/4" 2C lever reversible ratchet, fine-toothed, 72 teeth 150 mm 1/4" socket hexagon 4 4.5 5 5.5 6 7 8 9 10 11 12 13 25 mm 1/4" socket extension 100 mm 1/4" sliding T-bar with slider 115 mm Bit adaptor 1/4" sq. x 1/4" hex 25 mm	190	110	52	16	0.620



R49003033

SOCKET SET 1/4"

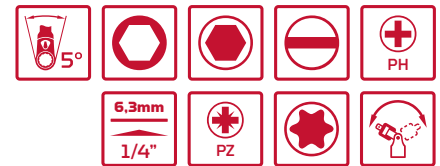

33 pieces

- > Coupler based on DIN 3120 - A 6.3, ISO 1174, with ball lock
- > Square drive as per DIN 3120 - C 6.3, ISO 1174, with ball retention groove
- > **2C reversible ratchet 1/4"**: lever for reversing clockwise/anticlockwise direction, push-button release, fine-toothed, oval head, dual-material handle for ease in handling, for sockets
- > **Square plug-in handle 1/4"**: 1-component handle with female square
- > **Socket 1/4", hex**: metric, short, as per DIN 3124, ISO 2725
- > **Screwdriver bit socket 1/4", for hex screws**: with pressed-in, phosphated pin
- > **Screwdriver bit socket 1/4", slotted**: with pressed-in, phosphated pin
- > **Screwdriver bit socket 1/4" PH**: with pressed-in, phosphated pin
- > **Screwdriver bit socket 1/4" PZ**: with pressed-in, phosphated pin
- > **Screwdriver bit socket 1/4" TX**: with pressed-in, phosphated pin
- > Socket extension 1/4"
- > **Universal joint 1/4"**: screwed-on joint, acc. to DIN 3123 - C 6.3
- > **Bit adaptor 1/4"**: with in-hex and female square, for all bits and tools with 1/4" external hex
- > Chrome-vanadium steel, matt satin chrome-plated
- > For hand-operated screw work
- > Plastic case in GEDORE red Design
- > Clamp-secured tools
- > Metal hinges/fastener



Code	No.	Contents	L	W	D	pieces	kg
3300051	R49003033	1/4" 2C lever reversible ratchet, fine-toothed, 72 teeth 150 mm 1/4" square plug-in handle 165 mm 1/4" socket hexagon 4 4.5 5 5.5 6 7 8 9 10 11 12 13 25 mm 1/4" screwdriver bit socket in-hex 4 4 5 6 37 mm 1/4" screwdriver bit socket slotted 4 5.5 6.5 37 mm 1/4" screwdriver bit socket cross-head PH 1 2 37 mm 1/4" screwdriver bit socket cross-head PZ 1 2 37 mm 1/4" screwdriver bit socket TX T15 T20 T25 T30 37 mm 1/4" socket extension 50 100 mm 1/4" universal joint 32 mm Bit adaptor 1/4" sq. x 1/4" hex 25 mm	300	180	52	33	1.310

R49003046

SOCKET SET 1/4"

46 pieces

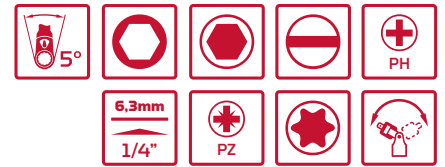

- > Coupler based on DIN 3120 - A 6.3, ISO 1174, with ball lock
- > Square drive as per DIN 3120 - C 6.3, ISO 1174, with ball retention groove
- > **2C reversible ratchet 1/4"**: lever for reversing clockwise/anticlockwise direction, push-button release, fine-toothed, oval head, dual-material handle for ease in handling, for sockets
- > **Square plug-in handle 1/4"**: 1-component handle with female square
- > **Socket 1/4", hex**: metric, short, as per DIN 3124, ISO 2725
- > **Screwdriver bit socket 1/4", for hex screws**: with pressed-in, phosphated pin
- > **Screwdriver bit socket 1/4", slotted**: with pressed-in, phosphated pin
- > **Screwdriver bit socket 1/4" PH**: with pressed-in, phosphated pin
- > **Screwdriver bit socket 1/4" PZ**: with pressed-in, phosphated pin
- > **Screwdriver bit socket 1/4" TX**: with pressed-in, phosphated pin
- > Socket extension 1/4"
- > Flexible socket extension 1/4"
- > **Sliding T-bar with slider 1/4"**: as per DIN 3122, ISO 3315
- > **Universal joint 1/4"**: screwed-on joint, acc. to DIN 3123 - C 6.3
- > **Bit adaptor 1/4"**: with in-hex and female square, for all bits and tools with 1/4" external hex
- > **Hexagon socket key set**: as per DIN ISO 2936
- > Chrome-vanadium steel, matt satin chrome-plated
- > For hand-operated screw work
- > Plastic case in GEDORE red Design
- > Clamp-secured tools
- > Metal hinges/fastener



Code	No.	Contents	L	W	D	pieces	
3300052	R49003046	1/4" 2C lever reversible ratchet, fine-toothed, 72 teeth 150 mm 1/4" square plug-in handle 165 mm 1/4" socket hexagon 4 4.5 5 5.5 6 7 8 9 10 11 12 13 14 25 mm 1/4" screwdriver bit socket in-hex 3 4 5 6 7 8 37 mm 1/4" screwdriver bit socket slotted 4 5.5 6.5 37 mm 1/4" screwdriver bit socket cross-head PH 1 2 3 37 mm 1/4" screwdriver bit socket cross-head PZ 1 2 37 mm 1/4" screwdriver bit socket TX T10 T15 T20 T25 T27 T30 T40 37 mm 1/4" socket extension 50 100 mm 1/4" flexible socket extension 150 mm 1/4" sliding T-bar with slider 115 mm 1/4" universal joint 32 mm Bit adapter 1/4" sq. x 1/4" hex 25 mm Hexagon socket key set 1.27 1.5 2 2.5 mm	300	180	52	46	1.570

R49005037

TOOL SET T-HANDLE WITH RATCHET 1/4"

37 pieces

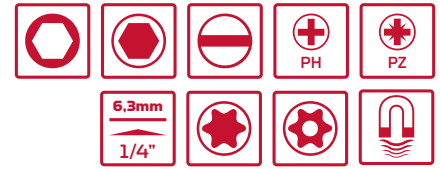

- > Handle for two working positions
- > Dual-material handle, for easy handling
- > In-hex for direct mounting of bits as per DIN 3126 - D 6.3
- > Ring for reversing clockwise/anticlockwise direction
- > Fine-toothed
- > 9x long all-steel blades with square drive and sockets
- > 1x long all-steel blade with square drive as bit holder or extension
- > Chrome-vanadium steel, satin matt chrome-plated
- > Bits in extra plastic holders
- > Plastic case with foam insert



Code	No.	Contents	L	W	D	pieces	📦
3300025	R49005037	2C ratchet hand grip with swivel 1/4" in-hex blade, ring change Socket hexagon 6 7 8 9 10 11 12 13 14 135 mm Bit holder 1/4" hex x 1/4" hex 135 mm 1/4" bit hexagon 3 4 5 6 8 mm 25 mm 1/4" bit slotted 4.5 5.5 6.5 25 mm 1/4" bit cross-head PH 1 2 2 3 25 mm 1/4" bit cross-head PZ 1 2 2 3 25 mm 1/4" bit TX T10 T15 T20 T25 T30 T40 25 mm 1/4" bit TX with drill hole T10 T15 T20 T25 25 mm	240	150	50	37	1.335

R49005023

BIT RATCHET SET 1/4" WITH ADAPTER COMPACT

23 pieces

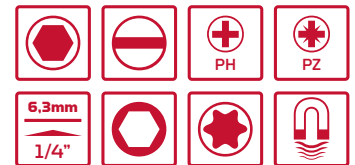

- > Coupler based on DIN 3120 - A 6.3, ISO 1174, with ball lock
- > Square drive as per DIN 3120 - C 6.3, ISO 1174, with ball retention groove
- > **Socket 1/4", hex:** metric, short, as per DIN 3124, ISO 2725
- > **Bit holder with magnet 1/4":** machine-operated, as per DIN 7427
- > **Adapter 1/4":** for driving sockets and sockets
- > **Bit ratchet:** lever for reversing clockwise/anticlockwise direction, fine-toothed, oval head, hexagon for direct fitting of bits based on DIN 3126 - D 6,3, with holding spring, sturdy all-steel design
- > **Bit:** in-hex, slotted, PH, PZ, TX
- > For hand-operated screw work
- > Rugged plastic box with belt clip
- > Transparent lid with clamp fastener
- > Chrome-vanadium steel, matt satin chrome-plated



Code	No.	Contents	L	W	D	pieces	📦
3300026	R49005023	Bit ratchet 1/4" reversible, with drive adapter Socket hexagon 6 7 8 10 11 12 13mm 1/4" bits in-hex 4 5 6 mm 1/4" bits slotted 5.5 mm 1/4" bits cross-head PH 1 2 1/4" bits cross-head PZ 1 2 1/4" bits TX T15 T20 T25 T27 T30 Adapter 1/4" square x 1/4" hexagon Bit holder 1/4" hex x 1/4" hex with magnet 67 mm	105	70	50	23	0.330

3/8" square drive

R59003026
SOCKET SET
3/8"

26 pieces



- > Coupler based on DIN 3120 - A 10, ISO 1174, with ball lock
- > Square drive as per DIN 3120 - C 10, ISO 1174, with ball retention groove
- > **2C reversible ratchet 3/8"**: lever for reversing clockwise/anticlockwise direction, push-button release, fine-toothed, oval head, dual-material handle for ease in handling, for sockets
- > **Socket 3/8"**: hex, metric, short, as per DIN 3124, ISO 2725
- > Spark plug socket 3/8" with pressed-in holding rubber and extra drive hex Size 19
- > Spark plug socket 3/8" with pressed-in holding rubber and extra drive hex Size 22
- > Socket extension 3/8"
- > **Sliding T-bar with slider 3/8"**: as per DIN 3122, ISO 3315
- > **Universal joint 3/8"**: screwed-on joint, acc. to DIN 3123 - C 10
- > Reducer 3/8" to 1/4"
- > Chrome-vanadium steel, matt satin chrome-plated
- > For hand-operated screw work
- > Plastic case in GEDORE red Design
- > Clamp-secured tools
- > Metal hinges/fastener



Code	No.	Contents	L	W	D	pieces	
3300053	R59003026	3/8" 2C lever reversible ratchet, fine-toothed, 72 teeth 180 mm 3/8" socket hexagon 6 7 8 9 10 11 12 13 14 15 16 17 18 19 20 21 22 24 mm 3/8" spark plug socket 16 21 mm 65 mm 3/8" socket extension 75 150 mm 3/8" sliding T bar with slider 200 mm 3/8" universal joint 48 mm Reducer 3/8" - 1/4" 27 mm	300	180	52	26	2.440

R59003059

SOCKET SET

3/8"

59 pieces



- > Coupler based on DIN 3120 - A 10, ISO 1174, with ball lock
- > Square drive as per DIN 3120 - C 10, ISO 1174, with ball retention groove
- > **2C reversible ratchet 3/8"**: lever for reversing clockwise/anticlockwise direction, push-button release, fine-toothed, oval head, dual-material handle for ease in handling, for sockets
- > **Socket 3/8"**: bi-hex, metric, short, as per DIN 3124, ISO 2725
- > **Socket 3/8"**: hex, metric, long, as per DIN 3124, ISO 2725
- > Spark plug socket 3/8" with pressed-in holding rubber and extra drive hex Size 19
- > Spark plug socket 3/8" with pressed-in holding rubber and extra drive hex Size 22
- > **Screwdriver bit socket 3/8"**: for hex screws, with pressed-in, phosphated pin
- > **Screwdriver bit socket 3/8"**: slotted, with pressed-in, phosphated pin
- > **Screwdriver bit socket 3/8" PH**: with pressed-in, phosphated pin
- > **Screwdriver bit socket 3/8" PZ**: with pressed-in, phosphated pin
- > **Screwdriver bit socket 3/8" TX**: with pressed-in, phosphated pin
- > Socket extension 3/8"
- > **Convector/slider 3/8" x 1/2"**: for driving sockets and screwdriver bit sockets
- > **Universal joint 3/8"**: screwed-on joint, acc. to DIN 3123 - C 10
- > Reducer 3/8" to 1/4"
- > Chrome-vanadium steel, matt satin chrome-plated
- > For hand-operated screw work
- > Plastic case in GEDORE red Design
- > Clamp-secured tools
- > Metal hinges/fastener

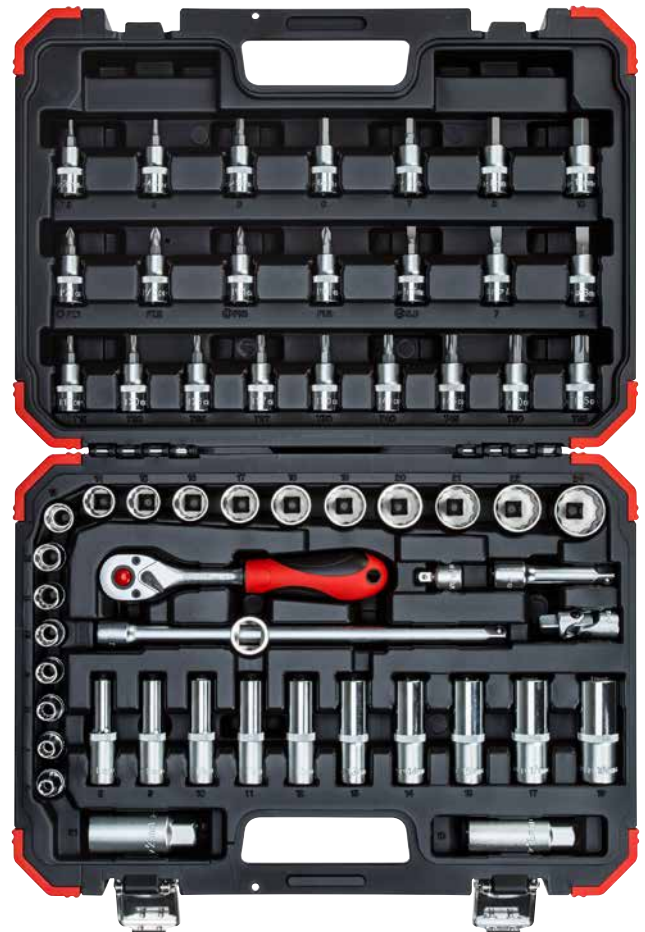

Code	No.	Contents	L	W	D	pieces	kg
3300054	R59003059	3/8" 2C lever reversible ratchet, fine-toothed, 72 teeth 180 mm 3/8" socket hexagon bi-hex 6 7 8 9 10 11 12 13 14 15 16 17 18 19 20 21 22 24 mm 3/8" socket hexagon hex long 8 9 10 11 12 13 14 15 17 19 L.63mm 3/8" spark plug socket 16 21 mm 65 mm 3/4" screwdriver bit socket in-hex 3 4 5 6 7 8 10 48 mm 3/4" screwdriver bit socket slotted 5.5 7 8 48 mm 3/8" screwdriver bit socket cross-head PH 1 2 48 mm 3/8" screwdriver bit socket cross-head PZ 1 2 48 mm 3/8" screwdriver bit socket TX T25 T27 T30 T40 T45 T50 T55 48 mm 3/8" socket extension 75 250 mm 3/8" universal joint 49 mm Reducer 3/8" - 1/4" 27 mm Socket extension piece/slider 3/8" x 1/2" 44 mm	383	272	80	59	4.8

R58003002

SCREWDRIVER BIT SOCKET SET 3/8" TX



10 pieces

- > Screwdriver bit socket 3/8": for recessed TX screws, square drive in acc. with DIN 3120 - C 10, ISO 1174, with ball retention groove
- > Long blades
- > Matt chrome-plated
- > Chrome-vanadium steel
- > Clamp-secured tools
- > Sturdy plastic case



Code	No.	Contents	L	W	D	pieces	kg
3301576	R58003002	Screwdriver bit socket TX T10 T15 T20 T25 T27 T30 T40 T45 T50 T55 200 mm	295	195	54	10	0.800

R19153000

EXTRACTOR SET 3/8"



14 pieces

- > For slackening and removing bolts and damaged screws
- > Anticlockwise cutting thread with 6 cutting edges tapering together
- > Square drive acc. to DIN 3120 - C 10, ISO 1174, with ball retention groove
- > Hexagon head at the sockets as alternative drive
- > **Hand-operated**
- > Special compact design
- > Special steel
- > In a robust plastic case



Code	No.	Contents	L	W	D	pieces	kg
3301563	R19153000	3/8": 6,3 mm (1/4") 8 mm (5/16") 9,5 mm (3/8") 10 mm (7/16") 12 mm 12,5 mm (1/2") 13 mm 14 mm (9/16") 16 mm (5/8") 17 mm 17,5 mm (11/16") 19 mm (3/4") Punch	190	110	40	14	0.730

1/2" square drive

R69004024 SOCKET SET 1/2"



24 pieces

- > Coupler based on DIN 3120 - A 12.5, ISO 1174, with ball lock
- > Square drive as per DIN 3120 - C 12.5, ISO 1174, with ball retention groove
- > **2C reversible ratchet 1/2"**: lever for reversing clockwise/anticlockwise direction, push-button release, fine-toothed, oval head, dual-material handle for ease in handling, for sockets
- > **Socket 1/2", hex**: metric, short, as per DIN 3124, ISO 2725
- > Socket extension 1/2"
- > **Sliding T-bar with slider 1/2"**: as per DIN 3122, ISO 3315
- > **Universal joint 1/2"**: screwed-on joint, acc. to DIN 3123 - C 12.5
- > **Bit adaptor 1/2"**: with in-hex and female square, for all bits and tools with 5/16" external hex
- > Chrome-vanadium steel, matt satin chrome-plated
- > For hand-operated screw work
- > Red sheet-steel case with foam insert



Code	No.	Contents	L	W	D	pieces	kg
330006	R69004024	1/2" 2C lever reversible ratchet, fine-toothed, 72 teeth 250 mm 1/2" socket hexagon 10 11 12 13 14 15 16 17 18 19 20 21 22 24 27 30 32 1/2" socket extension 75 125 250 mm 1/2" universal joint 66 mm 1/2" sliding T bar with slider 250 mm Bit adaptor 1/4" square x 5/16" hex 38 mm	575	187	51	24	5.344

R46004049 SOCKET SET 1/4" + 1/2"



49 pieces

- > Coupler in acc. with DIN 3120, ISO 1174, with ball locking device
- > Square drive as per DIN 3120, ISO 1174, with ball retention groove
- > **2C reversible ratchet**: lever for reversing clockwise/anticlockwise direction, push-button release, fine-toothed, oval head, dual-material handle for ease in handling, for sockets
- > **Socket hex**: metric, short, as per DIN 3124, ISO 2725
- > **Screwdriver bit socket 1/4", for hex screws**: with pressed-in, phosphated pin
- > **Screwdriver bit socket 1/4", slotted**: with pressed-in, phosphated pin
- > **Screwdriver bit socket 1/4" PH**: with pressed-in, phosphated pin
- > **Screwdriver bit socket 1/4" PZ**: with pressed-in, phosphated pin
- > **Screwdriver bit socket 1/4" TX**: with drill hole, with pressed-in, phosphated pin
- > Socket extension
- > **Universal joint**: screwed-on joint, acc. to DIN 3123 - C 6.3
- > **Bit adaptor 1/2" with in-hex and female square**: for all bits and tools with 5/16" external hex
- > Chrome-vanadium steel, matt satin chrome-plated
- > For hand-operated screw work
- > Red sheet-steel case with foam insert



Code	No.	Contents	L	W	D	pieces	kg
3300010	R46004049	1/4" 2C lever reversible ratchet, fine-toothed, 72 teeth 150 mm 1/4" socket hexagon 4 4.5 5 5.5 6 7 8 9 10 11 12 13 25 mm 1/4" screwdriver bit socket in-hex 4 5 6 8 37 mm 1/4" screwdriver bit socket slotted 5.5 37 mm 1/4" screwdriver bit socket cross-head PH 2 37 mm 1/4" screwdriver bit socket cross-head PZ 2 37 mm 1/4" screwdriver bit socket TX with drill hole T10 T15 T20 T25 T27 T30 T40 37 mm 1/4" socket extension 50 100 mm 1/4" universal joint 32 mm 1/2" 2C lever reversible ratchet, fine-toothed, 72 teeth 250 mm 1/2" socket hexagon 10 11 12 13 14 15 16 17 18 19 21 22 24 1/2" socket extension 75 125 250 mm 1/2" universal joint 66 mm Bit adaptor 1/4" square x 5/16" hex 38 mm	575	187	51	49	5.142

R69003024

SOCKET SET 1/2"



24 pieces

- > Coupler based on DIN 3120 - A 12.5, ISO 1174, with ball lock
- > Square drive as per DIN 3120 - C 12.5, ISO 1174, with ball retention groove
- > **2C reversible ratchet 1/2"**: lever for reversing clockwise/anticlockwise direction, push-button release, fine-toothed, oval head, dual-material handle for ease in handling, for sockets
- > **Socket 1/2", hex**: metric, short, as per DIN 3124, ISO 2725
- > Spark plug socket 1/2" with pressed-in holding rubber
- > Spark socket 1/2" with pressed-in holding rubber and extra drive hex Size 24
- > Socket extension 1/2"
- > Sliding T-bar with slider 1/2", as per DIN 3122, ISO 3315
- > **Universal joint 1/2"**: screwed-on joint, acc. to DIN 3123 - C 12.5
- > Chrome-vanadium steel, matt satin chrome-plated
- > For hand-operated screw work
- > Plastic case in GEDORE red Design
- > Clamp-secured tools
- > Metal hinges/fastener



Code	No.	Contents	L	W	D	pieces	kg
3300055	R69003024	1/2" 2C lever reversible ratchet, fine-toothed, 72 teeth 250 mm 1/2" socket hexagon 10 11 12 13 14 15 16 17 18 19 20 21 22 24 27 30 32 1/2" spark plug socket 16 21 mm 65 mm 1/2" socket extension 125 250 mm 1/2" universal joint 66 mm 1/2" sliding T bar with slider 250 mm	383	272	80	24	4.430

R69013024

SOCKET SET 1/2"



24 pieces

- > Coupler based on DIN 3120 - A 12.5, ISO 1174, with ball lock
- > Square drive as per DIN 3120 - C 12.5, ISO 1174, with ball retention groove
- > **2C reversible ratchet 1/2"**: lever for reversing clockwise/anticlockwise direction, push-button release, fine-toothed, oval head, dual-material handle for ease in handling, for sockets
- > **Socket 1/2", bi-hex**: metric, short, as per DIN 3124, ISO 2725
- > Socket extension 1/2"
- > **Convertor/slider 3/8" x 1/2"**: for driving sockets and screwdriver bit sockets
- > Chrome-vanadium steel, matt satin chrome-plated
- > For hand-operated screw work
- > Plastic case in GEDORE red Design
- > Clamp-secured tools
- > Metal hinges/fastener



Code	No.	Contents	L	W	D	pieces	kg
3300056	R69013024	1/2" 2C lever reversible ratchet, fine-toothed, 72 teeth 250 mm 1/2" socket bi-hex 10 11 12 13 14 15 16 17 18 19 20 21 22 23 24 26 27 28 30 32 1/2" socket extension 125 250 mm Socket extension piece/slider 3/8" x 1/2" 44 mm	383	272	80	24	4.750

R46003092

SOCKET SET

1/4" + 1/2"

92 pieces



- > Coupler in acc. with DIN 3120, ISO 1174, with ball locking device
- > Square drive as per DIN 3120, ISO 1174, with ball retention groove
- > **2C reversible ratchet:** lever for reversing clockwise/anticlockwise direction, push-button release, fine-toothed, oval head, dual-material handle for ease in handling, for sockets
- > **Square plug-in handle 1/4":** 1-component handle with female square
- > **Socket 1/4" + 1/2":** hex, metric, as per DIN 3124, ISO 2725
- > Spark plug socket 1/2" with pressed-in holding rubber and extra drive hex Size 23
- > Socket extension 1/4"+1/2"
- > **Sliding T-bar with slider 1/4":** as per DIN 3122, ISO 3315
- > **Universal joint 1/4" + 1/2":** screwed-on joint, as per DIN 3123 - C 12.5
- > **Convertor/slider 3/8" x 1/2":** for driving sockets and screwdriver bit sockets
- > **Bit adaptor 1/4":** with in-hex and female square, for all bits and tools with 1/4" external hex
- > **Bit adaptor 1/2":** with in-hex and female square, for all bits and tools with 5/16" external hex
- > **Bit holder with magnet 1/4":** machine-operated, as per DIN 7427
- > **Bit 1/4":** hex, slotted, PH, PZ, TX for holder as per DIN ISO 1173 - D 6,3
- > **Bit 5/16":** TX for holder as per DIN 1173, ISO 8
- > **Double swivel-head wrench:** bi-hex, metric, screwed on joint
- > **Combination spanner:** as per DIN 3113, Form A, ISO 3318, ISO 7738, 15° ring side angle, 15° jaw position
- > **Hexagon socket key set:** as per DIN ISO 2936
- > Plastic magazine for small parts
- > For hand-operated screw work
- > Chrome-vanadium steel, matt satin chrome-plated
- > Plastic case in GEDORE red Design
- > Clamp-secured tools
- > Metal hinges/fastener



Code	No.	Contents	L	W	D	pieces	Weight
3300062	R46003092	1/4" 2C lever reversible ratchet, fine-toothed, 72 teeth 150 mm 1/4" square plug-in handle 165 mm 1/4" socket hexagon 4 4.5 5 5.5 6 7 8 9 10 11 12 13 mm 1/4" socket hexagon 4 5 6 7 8 9 10 11 12 13mm 50 mm 1/4" socket extension 50 100 mm 1/4" sliding T-bar with slider 115 mm 1/4" universal joint 32 mm Bit holder 1/4" hex x 1/4" hex with magnet 60 mm Bit adapter 1/4" sq. x 1/4" hex 25 mm Drive adapter 1/4" hex x square with ball lock 25 mm 1/4" bits in-hex 3 4 5 6 8 10 25 mm 1/4" bits slotted 4 5.5 7 25 mm 1/4" bits cross-head PH 0 1 2 3 4 25 mm 1/4" bits cross-head PZ 1 2 3 25 mm 1/4" bits TX T8 T10 T15 T20 T25 T27 T30 T40 25 mm 5/16" bits socket TX T45 T50 T55 30 mm 1/2" 2C lever reversible ratchet, fine-toothed, 72 teeth 250 mm 1/2" socket hexagon 10 11 12 13 6 15 17 19 22 24 27 30 32 mm 1/2" spark plug socket 21 mm (13/16") 65 mm 1/2" socket extension 125 250 mm 1/2" universal joint 65 mm Socket extension piece/slider 3/8" x 1/2" 44 mm Bit adapter 1/4" square x 5/16" hex 38 mm Double swivel head wrenches 8x9 10x11 12x13 14x15 mm Combination spanners 8 10 12 13 14 17mm Hexagon socket key 1.5, 2 2.5 mm	383	272	80	92	5.850

R46003094

SOCKET SET

1/4" + 1/2"

94 pieces



- > Coupler in acc. with DIN 3120, ISO 1174, with ball locking device
- > Square drive as per DIN 3120, ISO 1174, with ball retention groove
- > **2C reversible ratchet:** lever for reversing clockwise/anticlockwise direction, push-button release, fine-toothed, oval head, dual-material handle for ease in handling, for sockets
- > **Square plug-in handle 1/4":** 1-component handle with female square
- > **Socket 1/4" + 1/2":** hex, metric, short, as per DIN 3124, ISO 2725
- > **Socket 1/4" + 1/2":** hex, metric, long, as per DIN 3124, ISO 2725
- > Spark plug socket 1/2" with pressed-in holding rubber
- > Spark plug socket 1/2" with pressed-in holding rubber and extra drive hex Size 24
- > **Screwdriver bit socket 1/4", for hex screws:** with pressed-in, phosphated pin
- > **Screwdriver bit socket 1/4", slotted:** with pressed-in, phosphated pin
- > **Screwdriver bit socket 1/4" PH:** with pressed-in, phosphated pin
- > **Screwdriver bit socket 1/4" PZ:** with pressed-in, phosphated pin
- > **Screwdriver bit socket 1/4" TX:** with pressed-in, phosphated pin
- > Socket extension 1/4"+1/2"
- > **Sliding T-bar with slider 1/4":** as per DIN 3122, ISO 3315
- > **Universal joint 1/4" + 1/2":** screwed-on joint, as per DIN 3123 - C 12.5
- > **Convertor/slider 3/8" x 1/2":** for driving sockets and screwdriver bit sockets
- > Bit adaptor 1/2", with female square and in-hex, for all bits and tools with 5/16" external hex
- > **Bit 5/16":** hex, slotted, PH, PZ, TX for holder as per DIN ISO 1173 - D 8
- > **Hexagon socket key set:** as per DIN ISO 2936
- > For hand-operated screw work
- > Chrome-vanadium steel, matt satin chrome-plated
- > Plastic case in GEDORE red Design
- > Clamp-secured tools
- > Metal hinges/fastener



Code	No.	Contents	L	W	D	pieces	€
3300057	R46003094	1/4" 2C lever reversible ratchet, fine-toothed, 72 teeth 150 mm 1/4" square plug-in handle 165 mm 1/4" socket hexagon 4 4.5 5 5.5 6 7 8 9 10 11 12 13 14 25 mm 1/4" screwdriver bit socket in-hex 4 4.5 6 37 mm 1/4" screwdriver bit socket slotted 4 5.5 6.5 37 mm 1/4" screwdriver bit socket cross-head PH 1 2 37 mm 1/4" screwdriver bit socket cross-head PZ 1 2 37 mm 1/4" screwdriver bit socket TX T8 T10 T15 T20 T25 T27 T30 37 mm 1/4" socket extension 50 100 mm 1/4" sliding T-bar with slider 115 mm 1/4" universal joint 32 mm 5/16" bits in-hex 8 10 12 14 30 mm 5/16" bits slotted 8 10 12 30 mm 5/16" bits cross-head PH 3 4 30 mm 5/16" bits cross-head PZ 3 4 30 mm 5/16" bits TX T40 T45 T50 T55 30 mm 1/2" 2C lever reversible ratchet, fine-toothed, 72 teeth 250 mm 1/2" socket hex 10 11 12 13 14 15 16 17 18 19 20 21 22 23 24 27 28 30 32 1/2" socket hexagon 14 15 17 19 77 mm 1/2" spark plug socket 16 21 mm 65 mm 1/2" socket extension 125 250 mm 1/2" universal joint 66 mm Socket extension piece/slider 3/8" x 1/2" 44 mm Bit adapter 1/4" square x 5/16" hex 38 mm Hexagon socket key set 1.5, 2 2.5 mm	383	272	80	94	6.770

R46003100

SOCKET SET

1/4" + 1/2"

100 pieces

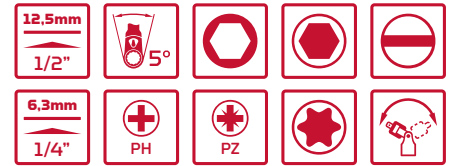

- > Coupler in acc. with DIN 3120, ISO 1174, with ball locking device
- > Square drive as per DIN 3120, ISO 1174, with ball retention groove
- > **2C reversible ratchet:** lever for reversing clockwise/anticlockwise direction, push-button release, fine-toothed, oval head, dual-material handle for ease in handling, for sockets
- > **Socket 1/4" + 1/2":** hex, metric, as per DIN 3124, ISO 2725
- > Socket extension 1/4"+1/2"
- > **Sliding T-bar with slider 1/4":** as per DIN 3122, ISO 3315
- > **Universal joint 1/4" + 1/2":** screwed-on joint, as per DIN 3123 - C 12.5
- > **Bit adaptor 1/4":** with female square and in-hex, for all bits and tools with 1/4" external hex
- > **Bit 1/4":** hex, slotted, PH, PZ, TX fits holder as per DIN ISO 1173 - D 6,3
- > **Combination spanner:** as per DIN 3113, Form A, ISO 3318, ISO 7738, 15° ring side angle, 15° jaw position
- > **Hexagon socket key set:** 9-piece, in the plastic socket holder, with ball head, for in-hex screws
- > **Adjustable wrench:** 15° jaw position, head polished with laser-marked scale
- > 1C screwdriver slotted, PH
- > **Side cutter:** dual-material handle, hands-friendly transfer of force
- > **Straight telephone pliers:** straight gripping surfaces, toothed lengthways, dual-material handle, hands-friendly transfer of force
- > **Water pump pliers, 7-setting adjustment:** head and "Gewerbe" polished, dual-material handle, hands-friendly transfer of force
- > **Engineers' hammer:** forged hammer head, in black, of tempered steel
- > Plastic case in GEDORE red Design
- > Clamp-secured tools
- > Metal hinges/fastener

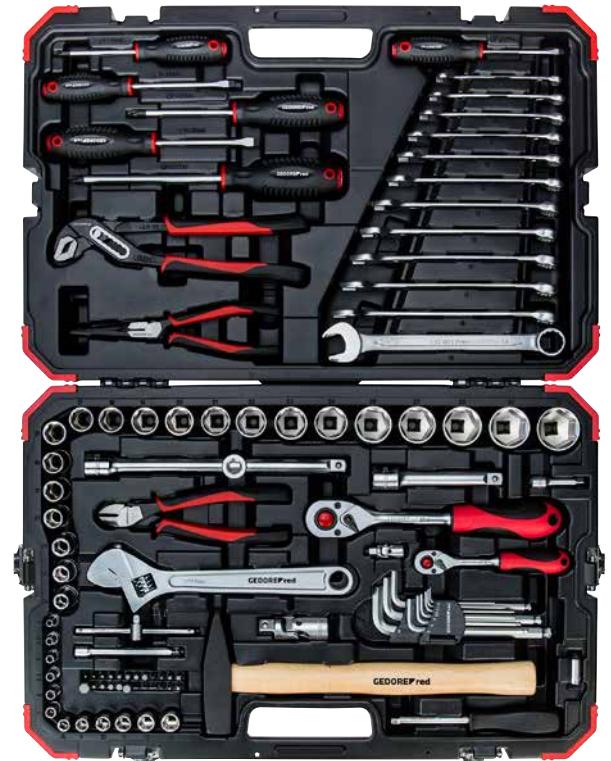

Code	No.	Contents	L	W	D	pieces	kg
3300063	R46003100	1/4" 2C lever reversible ratchet, fine-toothed, 72 teeth 150 mm 1/4" square plug-in handle 165 mm 1/4" socket hexagon 4 4.5 5 5.5 6 7 8 9 10 11 12 13 mm 1/4" socket extension 50 100 mm 1/4" sliding T-bar with slider 115 mm 1/4" universal joint 32 mm Bit adapter 1/4" sq. x 1/4" hex 25 mm 1/4" bits in-hex 3 4 5 6 8 10 25 mm 1/4" bits slotted 4 5.5 7 25 mm 1/4" bits cross-head PH 1 2 3 4 25 mm 1/4" bits cross-head PZ 1 2 3 25 mm 1/4" bits TX T8 T10 T15 T20 T25 T27 T30 T40 25 mm 1/2" 2C lever reversible ratchet, fine-toothed, 72 teeth 250 mm 1/2" socket hex 10 11 12 13 14 15 16 17 18 19 20 21 22 23 24 26 27 28 30 32 mm 1/2" socket extension 125 250 mm 1/2" universal joint 65 mm Socket extension piece/slider 3/8" x 1/2" 44 mm Combination spanners 8 9 10 11 12 13 14 15 16 17 18 19 mm Hexagon socket key set 1.5 2 2.5 3 4 5 6 8 10 mm Adjustable spanner 10 "250 mm Screwdriver slotted 4 5.5 6.5 Screwdriver cross-head PH 1 2 3 Side cutter 180 mm Telephone pliers 200 mm Water pump pliers 10" 250 mm Hammer 500 g	552	360	100	100	10.000

R45603172

SOCKET SET

1/4" + 3/8" + 1/2"

172 pieces

- > Coupler in acc. with DIN 3120, ISO 1174, with ball locking device
- > Square drive as per DIN 3120, ISO 1174, with ball retention groove
- > **2C reversible ratchet:** lever for reversing clockwise/anticlockwise direction, push-button release, fine-toothed, oval head, dual-material handle for ease in handling, for sockets
- > **Square plug-in handle 1/4":** 1-component handle with female square
- > **Socket hex, metric, short, as per DIN 3124, ISO 2725**
- > **Socket hex, metric, long, as per DIN 3124, ISO 2725**
- > Socket, recessed TX
- > Spark plug socket 3/8" with pressed-in holding rubber and extra drive hex Size 21
- > Spark plug socket 1/2" with pressed-in holding rubber
- > Spark plug socket 1/2" with pressed-in holding rubber and extra drive hex Size 24
- > **Screwdriver bit socket 1/4", for hex screws:** with pressed-in, phosphated pin
- > **Screwdriver bit socket 1/4", slotted:** with pressed-in, phosphated pin
- > **Screwdriver bit socket 1/4" PH:** with pressed-in, phosphated pin
- > **Screwdriver bit socket 1/4" PZ:** with pressed-in, phosphated pin
- > **Screwdriver bit socket 1/4" TX:** with pressed-in, phosphated pin
- > **Screwdriver bit socket 1/4" TX:** with drill hole, with pressed-in, phosphated pin
- > **Sliding T-bar with slider 1/4":** as per DIN 3122, ISO 3315
- > Socket extension 1/4" + 3/8" + 1/2"
- > **Universal joint 1/4" + 3/8" + 1/2":** screwed-on joint, as per DIN 3123 - C 12.5
- > **Convertor/slider 3/8" x 1/2":** for driving sockets and screwdriver bit sockets
- > **Bit adaptor 1/4":** with female square and in-hex, for all bits and tools with 1/4" external hex
- > **Bit adaptor 3/8":** with female square and in-hex, for all bits and tools with 5/16" external hex
- > **Bit adaptor 1/2":** with female square and in-hex, for all bits and tools with 5/16" external hex
- > **Bit 1/4", TX:** TX B0, TX security, B0, keyway, XZN for holder as per DIN 1173, ISO 6.3
- > **Bit 5/16":** in-hex, slotted, PH, TX, TX B0 for holder as per DIN ISO 1173 - D 8
- > Hexagon socket key set: as per DIN ISO 2936
- > For hand-operated screw work
- > Chrome-vanadium steel, matt satin chrome-plated
- > Plastic case in GEDORE red Design
- > Clamp-secured tools
- > Metal hinges/fastener

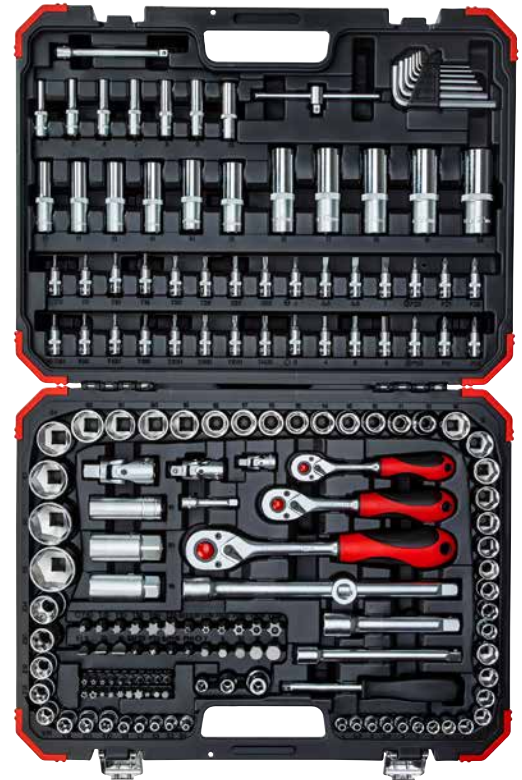
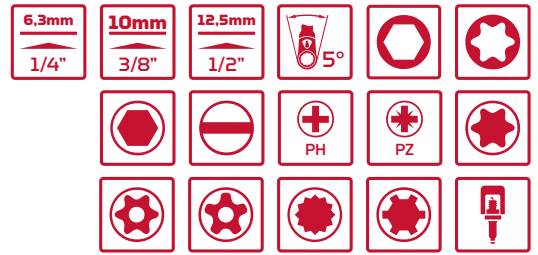

Code	No.	Contents	Contents continued	L	W	D	pieces		
3300058	R45603172	1/4" 2C lever reversible ratchet, fine-toothed, 72 teeth 150 mm 1/4" square plug-in handle 165 mm 1/4" socket hexagon 4 4.5 5 5.5 6 7 8 9 10 11 12 13 14 25 mm 1/4" socket hexagon 4 5 6 7 8 9 10 50 mm 1/4" socket TX E4 E5 E6 E7 E8 25 mm 1/4" screwdriver bit socket in-hex 4 4.5 6 37 mm 1/4" screwdriver bit socket slotted 4 5.5 6.5 7 37 mm 1/4" screwdriver bit socket cross-head PH 0 1 2 37 mm 1/4" screwdriver bit socket cross-head PZ 0 1 2 37 mm 1/4" screwdriver bit socket TX T8 T9 T10 T15 T20 T25 T27 T30 37 mm 1/4" screwdriver bit socket TX with drill hole T8 T9 T10 T15 T20 T25 T27 T30 37 mm 1/4" socket extension 50 100 mm 1/4" sliding T-bar with slider 115 mm 1/4" universal joint 32 mm Bit adapter 1/4" sq. x 1/4" hex 25 mm 1/4" bits TX T5 T6 T7 25 mm 1/4" bits TX with drill hole T7 25 mm 1/4" bits TX plus security T10 T15 T20 T25 T27 T30 T40 T45 25 mm 1/4" bits multi-point XZN M5 M6 M8 25 mm 1/4" bits keyway M5 M6 M7 M8 M9 25 mm 5/16" bits in-hex 7 8 10 12 14 30 mm 5/16" bits slotted 8 10 12 30 mm 5/16" bits cross-head PH 3 4 30 mm 5/16" bits cross-head PZ 3 4 30 mm 5/16" bits TX T40 T45 T50 T55 T60 T70 30 mm 5/16" bits TX with drill hole T40 T45 T50 T55 T60 T70 30 mm	3/8" 2C lever reversible ratchet, fine-toothed, 72 teeth 180 mm 3/8" socket hexagon 10 11 12 13 14 15 16 17 18 19 3/8" socket hexagon 10 11 12 13 14 15 63 mm 3/8" socket TX E10 E11 E12 E14 E16 E18 3/8" spark plug socket 18 mm 65 mm 3/8" socket extension 150 mm 3/8" universal joint 49 mm Bit adapter 3/8" square x 5/16" hex 30 mm 1/2" 2C lever reversible ratchet, fine-toothed, 72 teeth 250 mm 1/2" socket hexagon 10 11 12 13 14 15 16 17 18 19 20 21 22 24 27 30 32 1/2" socket hexagon 16 17 18 19 22 77 mm 1/2" socket 1/2 TX E20 E24 1/2" spark plug socket 16 21 mm 65 mm 1/2" socket extension 125 250 mm 1/2" universal joint 66 mm Socket extension piece/slider 3/8" x 1/2" 44 mm Bit adapter 1/2" square x 5/16" hex 38 mm Hexagon socket key 1.5 2 2.5 3 4 5 6 mm	452	340	86	172	10.500	

R68003016

SOCKET SET

1/2" TX



16 pieces

- > Coupler based on DIN 3120 - A 12.5, ISO 1174, with ball lock
- > Square drive as per DIN 3120 - C 12.5, ISO 1174, with ball retention groove
- > Socket 1/2", recessed TX
- > **Screwdriver bit socket 1/2" TX:** with pressed-in, phosphated pin
- > For hand-operated screw work
- > Chrome-vanadium steel, matt satin chrome-plated
- > Plastic case in GEDORE red Design
- > Clamp-secured tools
- > Metal hinges/fastener



Code	No.	Contents	L	W	D	pieces	
3300009	R68003016	Socket TX E10 E11 E12 E14 E16 E18 E20 E22 E24 Screwdriver bit socket TX T30 T40 T45 T50 T55 T60 T70	300	180	52	16	1.690

R68003010

EXTRACTOR SET 1/2"



10 pieces

- > Square drive acc. to DIN 3120 - C 12.5, ISO 1174, with ball retention groove
- > For slackening and removing bolts and damaged screws
- > Anticlockwise cutting thread with 6 cutting edges tapering together
- > Hexagon head at the sockets as alternative drive
- > **Hand-operated**
- > Special compact design
- > Special steel
- > In a robust plastic case



Code	No.	Contents	L	W	D	pieces	
3300034	R68003010	1/2" 10 11 12 13 14 15 16 17 19 mm Punch	130	130	55	10	0.950

R68003020

SOCKET SET

3/8" + 1/2"

TX, 20 pieces

- > Coupler in acc. with DIN 3120, ISO 1174, with ball locking device
- > Square drive as per DIN 3120, ISO 1174, with ball retention groove
- > Socket 3/8" + 1/2", recessed TX
- > **Screwdriver bit socket 3/8" + 1/2" TX:** with pressed-in, phosphated pin
- > Reducer 1/2" to 3/8"
- > Chrome-vanadium steel, matt satin chrome-plated
- > For hand-operated screw work
- > Plastic case in GEDORE red Design
- > Clamp-secured tools
- > Metal hinges/fastener



Code	No.	Contents	L	W	D	pieces	
3300045	R68003020	3/8" socket TX E6 E7 E8 E10 3/8" screwdriver bit socket TX T10 T15 T20 T25 T27 1/2" socket TX E12 E14 E16 E18 E20 1/2" screwdriver bit socket TX T30 T40 T45 T50 T55 Reducer 1/2" square x 3/8" square	300	180	52	20	2,000

R61003114

SOCKET SET 1/2"

Long design, 14 pieces

- > Square drive as per DIN 3120 - C 12.5, ISO 1174, with ball retention groove
- > **Socket 1/2", hex:** metric, long, as per DIN 3124, ISO 2725
- > Chrome-vanadium steel, matt satin chrome-plated
- > For hand-operated screw work
- > Plastic case in GEDORE red Design
- > Clamp-secured tools
- > Metal hinges/fastener



Code	No.	Contents	L	W	D	pieces	
3300008	R61003114	Socket hexagon 10 12 13 14 15 17 19 21 22 23 24 27 30 32 77 mm	383	272	80	14	3.746

R68003030

SCREWDRIVER BIT SOCKET SET

1/2" IN



30 pieces

- > Square drive acc. to DIN 3120 - C 12.5, ISO 1174, with ball retention groove
- > **Screwdriver bit socket 1/2", hex:** metric, with pressed-in, phosphated pin, non-slip longitudinal knurled head, brightly polished on the drive side, design based on DIN 7422
- > Chrome-vanadium steel, matt satin chrome-plated
- > For hand-operated screw work
Plastic case in the GEDORE red Design
- > Clamp-secured tools
- > Metal hinges/lock



Code	No.	Contents	L	W	D	pieces	kg
3301573	R68003030	Screwdriver bit socket in-hex, 5 6 7 8 10 12 14 17 19 55 mm Screwdriver bit socket, in-hex 5 6 7 8 10 11 12 13 100 mm Screwdriver bit socket in-hex 5 6 7 8 10 12 14 140 mm Screwdriver bit socket in-hex, 5 6 7 8 10 12 200 mm	425	320	52	30	5.4

R68003032

SCREWDRIVER BIT SOCKET SET

1/2" TX



32 pieces

- > Square drive acc. to DIN 3120 - C 12.5, ISO 1174, with ball retention groove
- > **Screwdriver bit socket 1/2", TX:** with pressed-in, phosphated pin, non-slip longitudinal knurled head, brightly polished on the drive side
- > Chrome-vanadium steel, matt satin chrome-plated
- > For hand-operated screw work
- > Plastic case in the GEDORE red Design
- > Clamp-secured tools
- > Metal hinges/lock



Code	No.	Contents	L	W	D	pieces	kg
3301577	R68003032	Screwdriver bit socket TX T20 T25 T27 T30 T40 T45 T50 T55 T60 T70 55 mm Screwdriver bit socket TX T20 T25 T27 T30 T40 T45 T50 T55 T60 T70 100 mm Screwdriver bit socket TX T40 T45 T50 T55 T60 T70 140 mm Screwdriver bit socket TX T40 T45 T50 T55 T60 T70 200 mm	425	320	52	32	5.4

R68003026

SCREWDRIVER BIT SOCKET SET

1/2" XZN



26 pieces

- > Square drive acc. to DIN 3120 - C 12.5, ISO 1174, with ball retention groove
- > **Screwdriver bit socket 1/2", XZN:** with pressed-in, phosphated pin, non-slip longitudinal knurled head, brightly polished on the drive side
- > Chrome-vanadium steel, matt satin chrome-plated
- > For hand-operated screw work
- > Plastic case in the GEDORE red Design
- > Clamp-secured tools
- > Metal hinges/lock



Code	No.	Contents	L	W	D	pieces	
3301574	R68003026	Screwdriver bit socket XZN M5 M6 M8 M9 M10 M12 M14 M16 55 mm Screwdriver bit socket XZN M5 M6 M8 M9 M10 M12 M14 100 mm Screwdriver bit socket XZN M5 M6 M8 M9 M10 M12 M14 140 mm Screwdriver bit socket XZN M8 M10 M12 M14 200 mm	425	320	52	26	5.4

R68003075

ASSEMBLY TOOL SET

TX 1/4" + 1/2"



75 pieces

- > Coupler in acc. with DIN 3120, ISO 1174, with ball locking device
- > Square drive acc. to DIN 3120, ISO 1174, with ball retention groove
- > Socket 1/4" + 1/2", recessed TX
- > **Screwdriver bit socket 1/4", TX:** with pressed-in, phosphated pin
- > **Bit adapter 1/4", with in-square and in-hex:** for all bits and tools with a 1/4" outer hex
- > **Bit adapter 1/2", with in-square and in-hex:** for all bits and tools with a 10mm (3/8") outer hex
- > **Bit 1/4" TX B0:** for holders in acc. with DIN ISO 1173 - D 6,3
- > **Bit 10mm (3/8") TX:** for holders in acc. with DIN ISO 1173 - D 10
- > Hexagon socket key set TX
- > Double-ended ring spanners TX
- > 1K screwdriver TX
- > Telescopic holder with magnet
- > Chrome-vanadium steel, matt satin chrome-plated
- > For hand-operated screw work
- > Plastic case in the GEDORE red Design
- > Clamp-secured tools
- > Metal hinges/lock



Code	No.	Contents	L	W	D	pieces	
3301575	R68003075	1/4" socket TX E4 E5 E6 E7 E8 E10 E11 25 mm 1/4" screwdriver bit socket TX T7 T8 T9 T10 T15 T20 T25 T27 T30 T40 37 mm 1/4" bit adapter square x hex 25 mm 1/4" bits TX with hole T7 T8 T9 T10 T15 T20 T25 T27 T30 T40 25 mm 1/2" socket TX E12 E14 E16 E18 E20 E22 E24 Bit adapter 1/2" 4kt x 10 mm 6kt 38 mm 10mm bits TX T40 T45 T50 T55 T60 30 mm 10mm bits TX T15 T20 T25 T30 T40 T45 T50 T55 T60 75 mm Screwdriver TX T8x60 T10x80 T15x80 T20x100 T25x100 T27x125 T30x125 T40x150 mm Double-ended ring spanner TX E6xE8 E10xE12 E14xE18 E20xE24 Hexagon socket key TX T8 T10 T15 T20 T25 T27 T30 T40 T45 T50 T55 T60 Telescopic magnetic lifter with scriber 126 - 636 mm	383	272	80	75	3,5

3/4" drive

R78004014
SOCKET SET 3/4"

14 pieces

- > Coupler as per DIN 3120 - B 20, ISO 1174, with locking pin
- > Square drive as per DIN 3120 - D 20, ISO 1174, with drill hole for locking pin
- > **Reversible ratchet 3/4"**: lever for reversing clockwise/anticlockwise direction, oval head, sturdy all-steel type
- > **Socket 3/4", hex**: metric, short, as per DIN 3124, ISO 2725
- > Socket extension 3/4"
- > **Sliding T-bar with slider 3/4"**: as per DIN 3122, ISO 3315
- > Chrome-vanadium steel, matt satin chrome-plated
- > For hand-operated screw work
- > Plastic case in GEDORE red Design
- > Clamp-secured tools
- > Metal hinges/fastener



Code	No.	Contents	L	W	D	pieces	
3300011	R78004014	3/4"reversible ratchet, coarse-cogged, 24 teeth 510 mm 3/4"socket hexagon 22 24 27 30 32 36 38 41 46 50 mm 3/4"socket extensions 200 400 mm 3/4" sliding T-bar with slider 460 mm	552	360	100	14	14.2

Sockets on holding rails

R41008012
SOCKETS 1/4"

Hexagon, metric, long, on holding rail, 12 pieces

- > 8" (200 mm) long metal holding rail
- > Sockets 1/4", hex: as per DIN 3124, ISO 2725
- > Hand-operated, longitudinal knurled grip
- > Drive end matt chrome-plated, driven end bright-polished
- > Square drive as per DIN 3120 - C 6.3, ISO 1174, with ball retention groove
- > Chrome-vanadium steel



Code	No.	Contents	pieces	
3300021	R41008012	Socket hexagon 4 4.5 5 5.5 6 7 8 9 10 11 12 13 50 mm	12	0.537

R48008013

SCREWDRIVER BIT SOCKETS 1/4"

In-hex, slotted, PH, on holding rail, 13 pieces



- > 8" (200 mm) long metal holding rail
- > Screwdriver bit socket 1/4", for hex screws: with pressed-in, phosphated pin
- > Screwdriver bit socket 1/4", slotted: with pressed-in, phosphated pin
- > Screwdriver bit socket 1/4" PH: with pressed-in, phosphated pin
- > Hand-operated, longitudinal knurled grip
- > Drive end brightly polished
- > Pressed-in phosphated pin
- > Square drive as per DIN 3120 - C 6.3, ISO 1174, with ball retention groove
- > Chrome-vanadium steel



Code	No.	Contents	pieces	kg
3300022	R48008013	In-hex 3 4 5 6 8 10 37 mm Slotted: 4 5.5 6,5 37 mm Cross-head PH: 0 1 2 3 37 mm	13	0.3

R58018012

SOCKETS

3/8" AND 1/2"

TX, on holding rail, 12 pieces



- > 11" (280 mm) long metal holding rail
- > Sockets 3/8" and 1/2", TX
- > Hand-operated, longitudinal knurled grip
- > Square drive as per DIN 3120, ISO 1174, with ball retention groove
- > Sliding T-bar with slider 3/8": as per DIN 3122, ISO 3315, matt chrome-plated, for hand-operated sockets, coupler based on DIN 3120 - A 10, ISO 1174, with ball lock
- > Socket extension piece/slider 3/8": for driving sockets and screwdriver sit sockets, square drive as per DIN 3120 - C 10, ISO 1174, with ball retention groove, coupler based on DIN 3120 - A 12,5, ISO 1174, with ball lock
- > Chrome-vanadium steel



Code	No.	Contents	pieces	kg
3300048	R58018012	3/8" sockets: TX E4 E5 E6 E8 28 mm 3/8" sliding T bar with slider 150 mm 1/2" sockets: TX E10 E12 E14 E16 E18 E20 38 mm Convertor 3/8" x 1/2" 44 mm	12	0.760

R61208007

SOCKETS 1/2"



TX, on holding rail, 7 pieces

- > 8" (200 mm) long metal holding rail
- > Socket sets 1/2", TX
- > Hand-operated, longitudinal knurled grip
- > Drive end matt chrome-plated, driven end bright-polished
- > Square drive as per DIN 3120 - C 12.5, ISO 1174, with ball retention groove
- > Chrome-vanadium steel



Code	No.	Contents	pieces	
3300028	R61208007	Screwdriver bit socket TX E10 E11 E12 E14 E16 E18 E20	7	0.460

R62558010

SCREWDRIVER BIT SOCKETS 1/2"



In-hex, metric on holding rail, 10 pieces

- > 11" (280 mm) long metal holding rail
- > Screwdriver bit socket 1/2", in-hex, as per DIN 7422
- > Hand-operated, longitudinal knurled grip
- > Drive end brightly polished
- > Pressed-in phosphated pin
- > Square drive as per DIN 3120 - C 12.5, ISO 1174, with ball retention groove
- > Chrome-vanadium steel



Code	No.	Contents	pieces	
3300023	R62558010	In-hex 5 6 7 8 10 11 12 14 17 55 mm	10	1.1

R6255 8110

SCREWDRIVER BIT SOCKETS 1/2"



In-hex, metric on holding rail, 10 pieces

- > 11" (280 mm) long metal holding rail
- > Screwdriver bit socket 1/2", in-hex, as per DIN 7422
- > Hand-operated, longitudinal knurled grip
- > Drive end brightly polished
- > Pressed-in phosphated pin
- > Square drive as per DIN 3120 - C 12.5, ISO 1174, with ball retention groove
- > Chrome-vanadium steel



Code	No.	Contents	pieces	
3300027	R62558110	In-hex 5 6 7 8 10 12 14 17 19 55 mm	10	1.140

R6245 8107

SCREWDRIVER BIT SOCKETS 1/2"



TX, on holding rail, 7 pieces

- > 8" (200 mm) long metal holding rail
- > Socket sets 1/2", TX
- > Pressed-in phosphated pin
- > Hand-operated, longitudinal knurled grip
- > Drive end brightly polished
- > Square drive as per DIN 3120 - C 12.5, ISO 1174, with ball retention groove
- > Chrome-vanadium steel



Code	No.	Contents	pieces	
3300029	R62458107	TX T20 T25 T27 T30 T40 T45 T50 55 mm	7	0.560

R68008009

SOCKETS/SOCKETS

1/2"



Hexagon, in-hex, metric on holding rail, 9 pieces

- > 9" (235 mm) long metal holding rail
- > Socket 1/2", hex: as per DIN 3124, ISO 2725
- > Screwdriver bit socket 1/2", in-hex, as per DIN 7422
- > Pressed-in phosphated pin
- > Hand-operated, longitudinal knurled grip
- > Square drive as per DIN 3120 - C 12.5, ISO 1174, with ball retention groove
- > Chrome-vanadium steel



Code	No.	Contents	pieces	
3301872	R68008009	Socket 10 13 15 17 19 mm Screwdriver bit socket 8 4 5 6 8 mm	9	0.610

R69008012

SOCKET SET 1/2"



Hexagon, metric, on holding rail, 12 pieces

- > 12" (305 mm) long metal holding rail
- 2-C reversible ratchet 1/2":**
 - > Lever for reversing clockwise/anticlockwise direction
 - > Push-button release
 - > Fine-toothed, working angle 5°
 - > Oval head
 - > Dual-material handle, for easy handling
 - > Matt chrome-plated surface
 - > For sockets, accessories etc. with square drive as per DIN 3120 - C 12.5, ISO 1174, with ball retention groove
 - > Chrome-vanadium steel
- Socket extension 1/2", 75 mm:**
 - > Matt chrome-plated
 - > For hand-operated sockets
 - > Square drive as per DIN 3120 - C 12.5, ISO 1174, with ball retention groove
 - > Coupler based on DIN 3120 - A 12.5, ISO 1174, with ball lock
 - > Chrome-vanadium steel
- Socket 1/2", hexagon:**
 - > Hand-operated, longitudinal knurled grip
 - > Drive end matt chrome-plated, driven end bright-polished
 - > Acc. to DIN 3124, ISO 2725
 - > Square drive as per DIN 3120 - C 12.5, ISO 1174, with ball retention groove
 - > Chrome-vanadium steel



Code	No.	Contents	pieces	
3300030	R69008012	2-C reversible ratchet 1/2" 250 mm Socket extension 1/2" 75 mm Sockets 1/2" 10 11 12 13 14 15 16 17 18 19 38 mm	12	1.300

R2085 XXXX

HOLDING RAIL FOR SOCKETS

- > Holding rail for equipping with adaptors for wrench sockets in drive sizes 1/4", 3/8" and 1/2"
- > Can also be used in combinations, for individual tool requirements
- > Can be loaded on both sides
- > In various lengths, with two elongated holes for fixing
- > Aluminium
- > Delivery without adapter



R20852031



Equipping example



R20852052

Code	No.	↳ "inch" ↳	↳ mm ↳	↳ kg ↳
3300014	R20852031	8	200	0.040
3300015	R20852052	12	305	0.060

MATCHING SOCKET HOLDER FOR HOLDING RAILS

Code	No.	■ "	■	W	H	↳ kg ↳
3300017	R20940004	1/4	6.3	26	18.5	0.020
3300018	R20940005	3/8	10.0	26	20.5	0.020
3300019	R20940006	1/2	12.5	26	23.0	0.040

Impact tools range

Impact tool sockets

R6300 3008

IMPACT TOOL SOCKET SET 1/2"



8 pieces

- > Square drive as per DIN 3121 - G 12.5, ISO 1174
- > Acc. to DIN 3129, ISO 2725-2
- > Machine-operated, fixing with safety ring / pin
- > Surface phosphated
- > Chrome-molybdenum steel
- > In rugged plastic case



Code	No.	Contents	L	W	D	pieces	↳ kg ↳
3300575	R63003008	Impact socket 1/2" 10 12 13 14 17 19 21 24 mm	190	110	52	8	1.100

R63003012

IMPACT TOOL SOCKET SET

1/2"



12 pieces

- > Square drive as per DIN 3121 - G 12.5, ISO 1174
- > Acc. to DIN 3129, ISO 2725-2
- > Machine-operated, fixing with safety ring / pin
- > Surface phosphated
- > Chrome-molybdenum steel
- > In rugged plastic case



Code	No.	Contents	L	W	D	pieces	
3300574	R63003012	Impact socket 10 11 12 13 14 15 16 17 19 21 22 24 mm	300	180	52	12	1.598

R63043003

IMPACT SOCKET SET

1/2"



3 pieces

- > Specially for fitting / removing wheels of vehicles
- > Plastic sleeves for damage-free work on aluminium wheel rims
- > Colour coding for ease in identifying the right size
- > Square drive as per DIN 3121 - G 12.5, ISO 1174
- > Acc. to DIN 3129, ISO 2725-2
- > Machine-operated, fixing with safety ring / pin
- > Surface phosphated
- > Chrome-molybdenum steel
- > In rugged plastic case



Code	No.	Contents	L	W	D	pieces	
3300578	R63043003	Impact socket 17 19 21 mm 86 mm	158	138	51	3	0.830

Impact sockets 1/2" drive

R6300XXXX
IMPACT SOCKET 1/2"

hexagon, short

- > Machine-operated, fixing with safety ring / pin
- > Surface phosphated
- > Acc. to DIN 3129, ISO 2725-2
- > Square drive as per DIN 3121 - G 12.5, ISO 1174
- > Chrome-molybdenum steel



Code	No.	□"	□	⊙mm	↳mm↳	∅1	∅2	⚖kg
3300525	R63001006	1/2	12.5	10	38	17.0	25.0	0.068
3300526	R63001106	1/2	12.5	11	38	18.5	25.0	0.075
3300527	R63001206	1/2	12.5	12	38	19.5	25.0	0.072
3300528	R63001306	1/2	12.5	13	38	21.0	25.0	0.072
3300529	R63001406	1/2	12.5	14	38	22.0	25.0	0.076
3300530	R63001506	1/2	12.5	15	38	23.5	30.0	0.076
3300531	R63001606	1/2	12.5	16	38	24.5	30.0	0.080
3300532	R63001706	1/2	12.5	17	38	26.0	30.0	0.088
3300533	R63001906	1/2	12.5	19	38	28.5	30.0	0.096
3300534	R63002106	1/2	12.5	21	38	31.0	30.0	0.114
3300535	R63002206	1/2	12.5	22	38	32.0	30.0	0.148
3300536	R63002408	1/2	12.5	24	45	35.0	30.0	0.154
3300537	R63002709	1/2	12.5	27	50	38.0	30.0	0.154
3300538	R63003009	1/2	12.5	30	50	41.0	30.0	0.240
3300539	R63003209	1/2	12.5	32	50	44.0	30.0	0.232

R6300XXXX
IMPACT SOCKET 1/2"

hexagon, long pattern

- > Machine-operated, fixing with safety ring / pin
- > Surface phosphated
- > Acc. to DIN 3129, ISO 2725-2
- > Square drive as per DIN 3121 - G 12.5, ISO 1174
- > Chrome-molybdenum steel



Code	No.	□"	□	⊙mm	↳mm↳	∅1	∅2	⚖kg
3300540	R63001016	1/2	12.5	10	78	17.0	25.0	0.126
3300541	R63001116	1/2	12.5	11	78	18.5	25.0	0.132
3300542	R63001216	1/2	12.5	12	78	19.5	25.0	0.144
3300543	R63001316	1/2	12.5	13	78	21.0	25.0	0.146
3300544	R63001416	1/2	12.5	14	78	22.0	25.0	0.170
3300545	R63001516	1/2	12.5	15	78	23.5	30.0	0.178
3300546	R63001616	1/2	12.5	16	78	24.5	30.0	0.218
3300547	R63001716	1/2	12.5	17	78	26.0	30.0	0.224
3300699	R63001815	1/2	12.5	18	78	27.5	30.0	0.260
3300548	R63001916	1/2	12.5	19	78	28.5	30.0	0.244
3300700	R63002015	1/2	12.5	20	78	30.0	30.0	0.280
3300549	R63002116	1/2	12.5	21	78	31.0	30.0	0.260
3300550	R63002216	1/2	12.5	22	78	32.0	30.0	0.338
3300701	R63002315	1/2	12.5	23	78	33.0	30.0	0.280
3300551	R63002416	1/2	12.5	24	78	35.0	30.0	0.350
3300703	R63002715	1/2	12.5	27	78	38.0	30.0	0.320
3300705	R63003015	1/2	12.5	30	78	41.0	30.0	0.350
3300706	R63003215	1/2	12.5	32	78	44.0	30.0	0.350

R6304XXXX

IMPACT SOCKET 1/2"



Hexagon with protective sleeve

- > Specially for fitting / removing wheels of vehicles
- > Plastic sleeves for damage-free work on aluminium wheel rims
- > Colour coding for ease in identifying the right size
- > Machine-operated, fixing with safety ring / pin
- > Surface phosphated
- > Square drive as per DIN 3121 - G 12.5, ISO 1174
- > Acc. to DIN 3129, ISO 2725-2
- > Chrome-molybdenum steel



Code	No.	□"	□	○mm	↳mm↳	Ø 1	Ø 2	Colour
3300585	R63041716	1/2	12.5	17	86	25.6	30	blue
3300586	R63041916	1/2	12.5	19	86	28.8	30	yellow
3300587	R63042116	1/2	12.5	21	86	30.8	30	red

Impact accessories 1/2"

R6610XXXX

IMPACT EXTENSION 1/2"



- > Machine-operated, fixing with safety ring / pin
- > Surface phosphated
- > Coupler as per DIN 3121 - F 12.5, ISO 1174
- > Square drive as per DIN 3121 - G 12.5, ISO 1174
- > Chrome-molybdenum steel



Code	No.	□"	□	■"	■	↳mm↳	Ø 1	Ø 2	kg
3300570	R66100024	1/2	12.5	1/2	12.5	125	16	25	0.230
3300571	R66100049	1/2	12.5	1/2	12.5	250	16	25	0.443

R6630 0014

IMPACT UNIVERSAL JOINT 1/2"



- > Machine-operated, fixing with safety ring / pin
- > Surface phosphated
- > Coupler as per DIN 3121 - F 12.5, ISO 1174
- > Square drive as per DIN 3121 - G 12.5, ISO 1174
- > Chrome-molybdenum steel



Code	No.	□"	□	■"	■	↳mm↳	Ø 1	Ø 2	kg
3300650	R66300014	1/2	12.5	1/2	12.5	63	34	30	0.236

R6740 0008

IMPACT SOCKET EXTENSION PIECE

1/2" TO 3/4"



- > Machine-operated, fixing with safety ring / pin
- > Surface phosphated
- > Coupler as per DIN 3121 - F 20, ISO 1174
- > Square drive as per DIN 3121 - G 12.5, ISO 1174
- > Chrome-molybdenum steel



Code	No.	□"	□	■"	■	↳ mm ◀	Ø 1	⚖
3300573	R67400008	1/2	12.5	3/4	20	49	30	0.140

R6760 0005

IMPACT SOCKET REDUCER

1/2" TO 3/8"



- > Machine-operated, fixing with safety ring / pin
- > Surface phosphated
- > Coupler as per DIN 3121 - F 10, ISO 1174
- > Square drive as per DIN 3121 - G 12.5, ISO 1174
- > Chrome-molybdenum steel



Code	No.	□"	□	■"	■	↳ mm ◀	Ø 1	⚖
3300572	R67600005	1/2	12.5	3/8	10	38	30	0.070

R6398 XXXX

SAFETY RING / 9 IN 1/2"

- > Consisting of safety ring and safety pin
- > For securing impact sockets



Code	No.	■"	■ Use	Model	⚖
3300576	R63981005	1/2	12.5 for size 8-14 mm	Pin 20 x 3 mm, ring 19 x 4 mm	0.003
3300577	R63981105	1/2	12.5 for size 15-32 mm	Pin 25 x 3 mm, ring 24 x 4 mm	0.005

Impact sockets 3/4" drive

R7300 XXXX SET IMPACT SOCKETS 3/4"



short

- > Machine-operated, fixing with safety ring / pin
- > Surface phosphated
- > Acc. to DIN 3129, ISO 2725-2
- > Square drive as per DIN 3121 - H 20, ISO 1174
- > Chrome-molybdenum steel



Code	No.	□"	□	⊙mm	↳mm↳	∅ 1	∅ 2	⚖
3300591	R73001909	3/4	20	19	51	32	44	0.340
3300593	R73002209	3/4	20	22	51	37	44	0.354
3300594	R73002309	3/4	20	23	51	38	44	0.340
3300595	R73002409	3/4	20	24	52	39	44	0.354
3300598	R73002710	3/4	20	27	54	43	44	0.388
3300599	R73002810	3/4	20	28	54	44	44	0.380
3300601	R73003010	3/4	20	30	54	46	44	0.428
3300602	R73003210	3/4	20	32	56	49	44	0.472
3300603	R73003310	3/4	20	33	56	50	44	0.506
3300606	R73003610	3/4	20	36	56	54	44	0.514
3300608	R73003811	3/4	20	38	58	56	44	0.564
3300609	R73004111	3/4	20	41	58	59	44	0.594
3300610	R73004611	3/4	20	46	63	65	44	0.850

R7300 XXXX SET IMPACT SOCKETS 3/4"



long

- > Machine-operated, fixing with safety ring / pin
- > Surface phosphated
- > Acc. to DIN 3129, ISO 2725-2
- > Square drive as per DIN 3121 - H 20, ISO 1174
- > Chrome-molybdenum steel



Code	No.	□"	□	⊙mm	↳mm↳	∅ 1	∅ 2	⚖
3300612	R73001917	3/4	20	19	90	32	44	0.426
3300614	R73002117	3/4	20	21	90	35	44	0.456
3300615	R73002217	3/4	20	22	90	37	44	0.496
3300617	R73002417	3/4	20	24	90	39	44	0.470
3300620	R73002717	3/4	20	27	90	43	44	0.506
3300623	R73003017	3/4	20	30	90	49	44	0.626
3300624	R73003217	3/4	20	32	90	50	44	0.598
3300651	R73003317	3/4	20	33	90	50	44	0.780
3300652	R73003617	3/4	20	36	90	54	44	0.800
3300654	R73004117	3/4	20	41	90	59	44	0.920
3300655	R73004617	3/4	20	46	90	65	44	1.400

Impact accessories 3/4"

R7510XXX
IMPACT EXTENSION
3/4"



- > Machine-operated, fixing with safety ring / pin
- > Surface phosphated
- > Coupler as per DIN 3121 - F 20, ISO 1174
- > Square drive as per DIN 3121 - H 20, ISO 1174
- > Chrome-molybdenum steel



Code	No.	□"	□	■"	■	↳mm↳	∅	⚖
3300631	R76100040	3/4	20	3/4	20.0	205		0.923
3300632	R76100059	3/4	20	3/4	20.0	300		1.223

R7740 0011
IMPACT SOCKET EXTENSION PIECE
3/4" TO 1"



- > Machine-operated, fixing with safety ring / pin
- > Surface phosphated
- > Coupler as per DIN 3121 - F 25, ISO 1174
- > Square drive as per DIN 3121 - H 20, ISO 1174
- > Chrome-molybdenum steel



Code	No.	□"	□	■"	■	↳mm↳	∅	⚖
3300637	R77400011	3/4	20.0	1	25	65	44	0.430

R7760 0010
IMPACT SOCKET REDUCER
3/4" TO 1/2"



- > Machine-operated, fixing with safety ring / pin
- > Surface phosphated
- > Coupler as per DIN 3121 - F 12,5, ISO 1174
- > Square drive as per DIN 3121 - H 20, ISO 1174
- > Chrome-molybdenum steel



Code	No.	□"	□	■"	■	↳mm↳	∅	⚖
3300633	R77600010	3/4	20.0	1/2	12.5	56	44	0.334

R73981005
SAFETY RING / 9IN 3/4"



- > Consisting of safety ring and safety pin
- > For securing impact sockets



Code	No.	■"	■ Use	Model	⚖
3300634	R73981005	3/4	20 for size 17-50 mm	Pin 35 x 4 mm, ring 36 x 5 mm	0.010

Impact sockets 1" drive

R8300XXXX IMPACT SOCKET 1"

hexagon, short



- > Machine-operated, fixing with safety ring / pin
- > Surface phosphated
- > Acc. to DIN 3129, ISO 2725-2
- > Square drive as per DIN 3121 - H 25, ISO 1174
- > Chrome-molybdenum steel



Code	No.	□"	□	⊙ mm	↳ mm ↲	∅ 1	∅ 2	⚖
3300657	R83002711	1	25	27	59	46.2	54	0.690
3300659	R83003011	1	25	30	61	50.0	54	0.710
3300660	R83003211	1	25	32	62	52.5	54	0.700
3300661	R83003311	1	25	33	62	54.0	54	0.690

R8300XXXX IMPACT SOCKET 1"

hexagon, long pattern



- > Machine-operated, fixing with safety ring / pin
- > Surface phosphated
- > Acc. to DIN 3129, ISO 2725-2
- > Square drive as per DIN 3121 - H 25, ISO 1174
- > Chrome-molybdenum steel



Code	No.	□"	□	⊙ mm	↳ mm ↲	∅ 1	∅ 2	⚖
3300674	R83002419	1	25	24	100	42.5	54	0.900
3300675	R83002719	1	25	27	100	46.2	54	1.000
3300676	R83003019	1	25	30	100	50.0	54	1.000
3300677	R83003219	1	25	32	100	52.5	54	1.100
3300678	R83003319	1	25	33	100	54.0	54	1.100
3300679	R83003619	1	25	36	100	57.5	54	1.200
3300680	R83003819	1	25	38	100	59.5	54	1.300
3300681	R83004119	1	25	41	100	62.0	54	1.400
3300682	R83004619	1	25	46	100	68.0	54	1.388

Impact accessories 1" drive

R8610059
IMPACT EXTENSION 1"

- > Machine-operated, fixing with safety ring / pin
- > Surface phosphated
- > Coupler as per DIN 3121 - F 25, ISO 1174
- > Square drive as per DIN 3121 - H 25, ISO 1174
- > Chrome-molybdenum steel



Code	No.	□"	□	■"	■	↳ mm ↳	⚖ kg
3300685	R86100059	1	25	1	25.0	300	2.030

**R83981105**
SAFETY RING / PIN 1"

- > Consisting of safety ring and safety pin
- > For securing impact sockets



Code	No.	■"	■ Use	Model	⚖ kg
3300708	R83981105	1	25 for size 24-80mm	Pin 45 x 5 mm, ring 45 x 7 mm	0.026

TORQUE WRENCHES

124 - 125



RX890 XXXX TORQUE WRENCHES

Use:

- > Controlled screw tightening from 5 to 550 N-m
- > For controlled bi-directional tightening
- > Repetition-accurate and precision-like
- > Torque triggering clearly to be heard and felt

Features:

- > Adjustable torque wrench with square drive and integrated ratchet-head function
- > Square drive with ratchet mechanism
- > Torque is set by turning the handle
- > The set value is fixed through the lock at the end of the handle
- > Easy-to-read scale with magnifying glass for N-m, plus 1/10 scale for precision setting
- > Actuation accuracy: +/- 3 % tolerance of the scale set torque

Scope of delivery:

- > Torque wrench with test certificate acc. to DIN EN ISO 6789
- > Operating instructions



Code	No.	Type	1/4"	3/8"	N-m	10-50 N-m	mm	kg
3301214	R48900025	Plug-in square with knob, serrated	1/4	6.3	5-25	0.1	285	0.515
3301871	R58900050	Plug-in square with knob, serrated	3/8	10.0	10-50	2.5	335	0.540
3301216	R68900100	Plug-in square with knob, serrated	1/2	12.5	20-100	0.5	395	1.176
3301217	R68900200	Plug-in square with knob, serrated	1/2	12.5	40-200	1.0	485	1.350
3301218	R68900300	Plug-in square with knob, serrated	1/2	12.5	60-300	1.0	575	1.541
3301219	R78900400	Push-through square head with pin	3/4	20.0	80-400	1.0	685	2.390
3301220	R78900550	Push-through square head with pin	3/4	20.0	110-550	1.0	955	4.184

Accessories

RX899 XXXX COUPLER

- > For use with tools with a square ratchet function
- > Coupler in acc. with DIN 3120
- > Chrome-vanadium steel



Code	No.	Type	1/4"	3/8"	kg
3301221	R48990000	Plug-in square with knob, serrated	1/4	6.3	0.021
3301222	R58990000	Plug-in square with knob, serrated	3/8	10.0	0.022
3301223	R68990000	Plug-in square with knob, serrated	1/2	12.5	0.060
3301224	R78991000	Push-through square head with pin	3/4	20.0	0.133

SCREWDRIVERS AND BITS

126 - 137

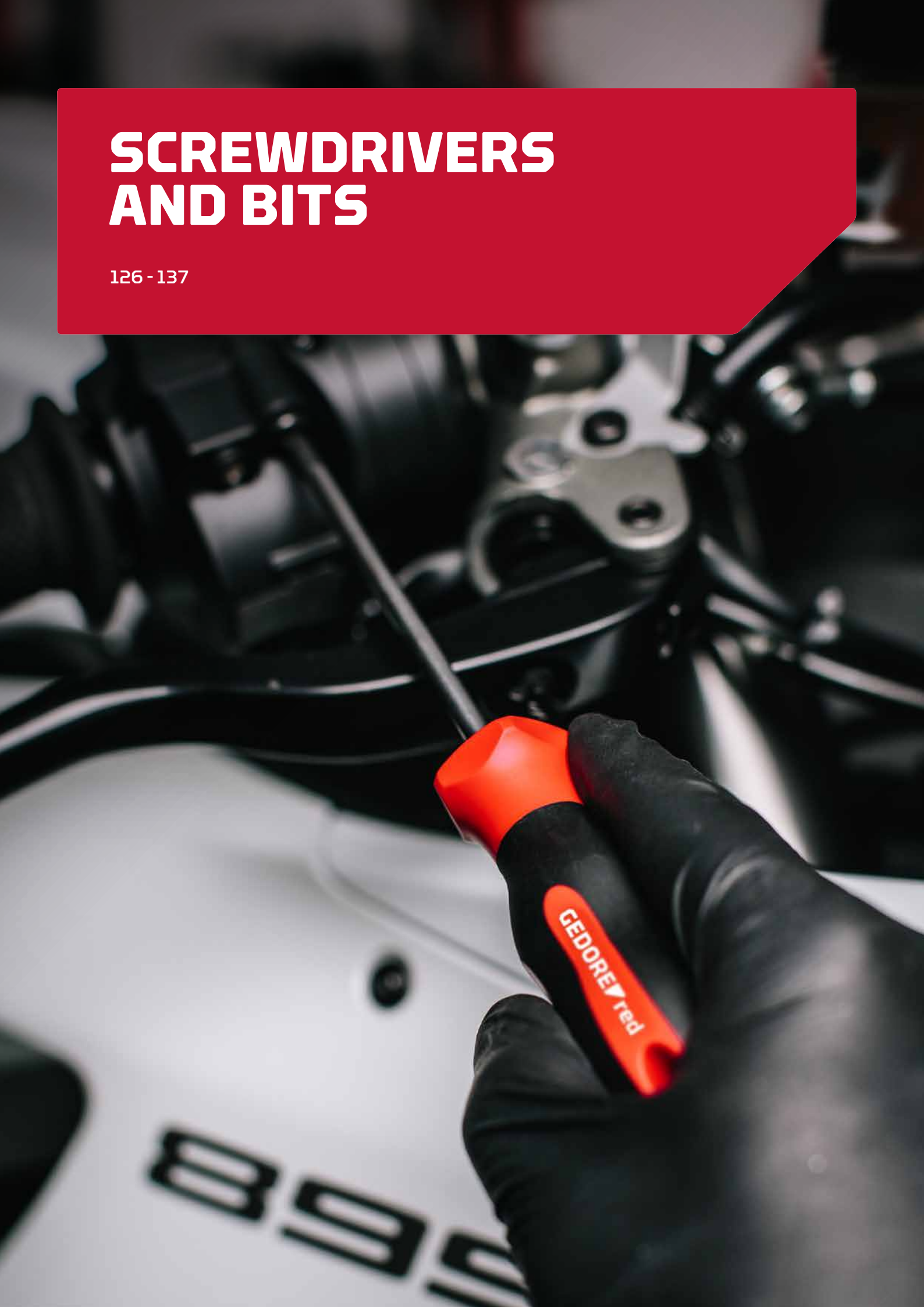

Screwdrivers

R3810XXXX

2C-SCREWDRIVER



Slotted

- > Acc. to DIN 5264
- > Blade of high-grade chrome-molybdenum steel, chrome-plated
- > Driven tip phosphated, corrosion-protected and low-wear
- > Moulded handle forms a firm unit with the blade
- > Dual-material handle for a hands-friendly transfer of force
- > 5-edge handle head stops it rolling off
- > Elongated hole in the handle for hanging up



Code	No.	mm	mm	mm	mm	Ø	kg
3301225	R38100315	3.0	0.5	75	145	3	0.030
3301226	R38100419	4.0	0.8	100	170	4	0.040
3301228	R38105519	5.5	1.0	100	200	5	0.080
3301233	R38106529	6.5	1.2	150	260	6	0.110
3301235	R38100829	8.0	1.2	150	272	8	0.160
3301237	R38101039	10.0	1.6	200	322	10	0.220

R3820XXXX

2C-SCREWDRIVER



PH

- > Acc. to DIN 8764
- > Blade of high-grade chrome-molybdenum steel, chrome-plated
- > Driven tip phosphated, corrosion-protected and low-wear
- > Moulded handle forms a firm unit with the blade
- > Dual-material handle for a hands-friendly transfer of force
- > 5-edge handle head stops it rolling off
- > Elongated hole in the handle for hanging up



Code	No.	PH	mm	mm	Ø	kg
3301242	R38200011	0	75	145	3	0.040
3301245	R38200119	1	100	200	5	0.070
3301247	R38200219	2	100	210	6	0.100
3301250	R38200329	3	150	272	8	0.100

R3830XXXX

2C-SCREWDRIVER



PZ

- > Acc. to DIN 8764
- > Blade of high-grade chrome-molybdenum steel, chrome-plated
- > Driven tip phosphated, corrosion-protected and low-wear
- > Moulded handle forms a firm unit with the blade
- > Dual-material handle for a hands-friendly transfer of force
- > 5-edge handle head stops it rolling off
- > Elongated hole in the handle for hanging up



Code	No.	PZ	mm	mm	Ø	kg
3301251	R38300119	1	100	200	5	0.080
3301252	R38300219	2	100	210	6	0.100
3301253	R38300329	3	150	272	8	0.160

R3840XXXX

2G-SCREWDRIVER



TX

- › Blade of high-grade chrome-molybdenum steel, chrome-plated
- › Driven tip phosphated, corrosion-protected and low-wear
- › Moulded handle forms a firm unit with the blade
- › Dual-material handle for a hands-friendly transfer of force
- › 5-edge handle head stops it rolling off
- › Elongated hole in the handle for hanging up

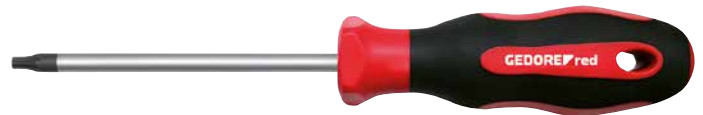

Code	No.				Ø	
3301262	R38401115	T10	100	200	5	0.025
3301263	R38401215	T15	100	200	5	0.039
3301264	R38401319	T20	100	200	5	0.044
3301265	R38401419	T25	100	210	6	0.062
3301266	R38401522	T27	100	210	6	0.080
3301267	R38401622	T30	100	210	6	0.101
3301268	R38401825	T40	100	210	7	0.125

R38002006

SCREWDRIVER SET



6 pieces

- › Acc. to DIN 5264 and DIN 8764
- › Blades of high-grade chrome-molybdenum steel, chrome-plated
- › Driven tips phosphated, corrosion-protected and low-wear
- › Moulded handles form a firm unit with the blades
- › Dual-material handles for a hands-friendly transfer of force
- › 5-edge handle heads stop them rolling off
- › Elongated holes in the handle for hanging up



Code	No.	Contents	pieces	
3301270	R38002006	Slotted screwdriver 3 5.5 6.5 mm Cross-slotted screwdriver PH 0 1 2	6	0.435

R38002106

SCREWDRIVER SET



6 pieces

- > Acc. to DIN 5264 and DIN 8764
- > Blades of high-grade chrome-molybdenum steel, chrome-plated
- > Driven tips phosphated, corrosion-protected and low-wear
- > Moulded handles form a firm unit with the blades
- > Dual-material handles for a hands-friendly transfer of force
- > 5-edge handle heads stop them rolling off
- > Elongated holes in the handle for hanging up



Code	No.	Contents	pieces	kg
3301271	R38002106	Slotted screwdriver 3 5.5 6.5 mm Cross-slotted screwdriver PZ 0 1 2	6	0.435

R38002012

SCREWDRIVER SET XXL



12 pieces

- > Blades of high-grade chrome-molybdenum steel, chrome-plated
- > Driven tips phosphated, corrosion-protected and low-wear
- > Moulded handles form a firm unit with the blades
- > Dual-material handles for a hands-friendly transfer of force
- > 5-edge handle heads stop them rolling off
- > Elongated holes in the handle for hanging up



Code	No.	Contents	pieces	kg
3301273	R38002012	Slotted screwdriver 3 4 5.5 6.5 8 mm Cross-head screwdriver PH 1 2 Cross-head screwdriver PZ PZ 1 2 VDE slotted screwdriver 2.5 mm VDE cross-head screwdriver PH 1 Voltage tester 3 mm	12	0.927

R38402006

SCREWDRIVER SET TX



6 pieces

- › Blades of high-grade chrome-molybdenum steel, chrome-plated
- › Driven tips phosphated, corrosion-protected and low-wear
- › Moulded handles form a firm unit with the blades
- › Dual-material handles for a hands-friendly transfer of force
- › 5-edge handle heads stop them rolling off
- › Elongated holes in the handle for hanging up



Code	No.	Contents	pieces	
3301272	R38402006	TX screwdriver T10 T15 T20 T25 T30 T40	6	0.550

R38005906

2C-ELECTRONICS SCREWDRIVER SET



6 pieces

- › 2C-handles, ergonomically formed, with quick-turning end caps
- › Screwdriver blades of chrome-molybdenum steel, chrome-plated



Code	No.	Contents	pieces	
3301351	R38005906	Slotted screwdrivers 1.5 1.8 2.5 3 mm Cross-head screwdriver PH 00 0	6	0.370

R38120312

PHASE TESTER 105-250V



- › Integrated glow lamp and series resistor for networks from 105 to a max. 250 volt
- › Single-component handle for a hands-friendly transfer of force
- › Impact-resistant, transparent plastic
- › Metal clip for fastening



Code	No.				
3301420	R38120312	3.0	7.0	1.44	0.030

R38121312

PHASE TESTER MAX. 250V



- > Integrated glow lamp and series resistor for networks up to a max. 250 volt
- > Black gunmetal finished tip
- > Red plastic jacket
- > Anti-slip handle surface
- > Plastic clip for fastening
- > Triangular hole in the handle for hanging up
- > Acc. to DIN 0680-6:1977-04



Code	No.	mm $\frac{1}{4}$ "	mm	kg
3301419	R38121312	3.0	135	0.028

R38120419

PHASE TESTER 220-250V



- > Integrated glow lamp and series resistor for networks from 220 to a max. 250 volt
- > Single component handle for a hands-friendly transfer of force
- > Impact-resistant, transparent plastic
- > Metal clip for fastening



Code	No.	mm $\frac{1}{4}$ "	mm	kg
3301421	R38120419	4.0	190	0.036

R38910000

RATCHET SCREWDRIVER 1/4" WITH TELESCOPIC BLADE



- > Telescopic blade infinitely adjustable
- > Quick-grip system for hex bits as per DIN 3126 - C 6.3 + E 6.3 (1/4")
- > Reversible clockwise/anticlockwise ratchet function
- > Ratchet lock in central position
- > Dual-material handle for a hands-friendly transfer of force



Code	No.	1/4"	6.3	mm	mm	kg
3301341	R38910000	1/4	6.3	0-100	183-287	0.223

R3892 0000

EXTENDABLE SHANK SCREWDRIVER 13IN1



- > The all-rounder: 13 screwdriver profiles in the magazine
- > Screwdriver handle with integrated ratchet function, reversible
- > Hex recess drive as per DIN 3126 - D 6.3 (1/4"), for bits
- > Lockable telescopic blade, continuously adjustable
- > Reversible clockwise/anticlockwise ratchet function
- > Ratchet lock in central position
- > Dual-material handle for a hands-friendly transfer of force



Code	No.	Contents	Blade length	Length of handle	pieces	
3301337	R38920000	Extendable shank screwdriver with 1/4" bits Slotted 4 4.5 5.5 mm Phillips PH 1 2 3 Cross-head PZ 1 PZ 2 TX T10 T15 T20 T25 Hexagon 4 mm	55-128	135	14	0.280

R3895 0000

BIT SCREWDRIVER 1/4"



- > Dual-material handle, for easy handling
- > Hex recess drive as per DIN 3126 - D 6.3 (1/4"), for bits
- > Bit holder with strong magnet
- > Elongated hole in the handle for hanging up
- > Chrome-vanadium steel



Code	No.					
3301343	R38950000	1/4	6.3	100	210	0.110

R3895 0001

SQUARE PLUG-IN HANDLE 1/4"



- > For hand-operated sockets with square drive as per DIN 3120, ISO 1174, with ball locking device
- > Dual-material handle, for easy handling
- > Matt chrome-plated
- > Coupler in acc. with DIN 3120 - A 6.3, ISO 1174, with ball locking device
- > Female square in the handle suitable for ratchet-performed drive as per DIN 3120 - C 6.3, ISO 1174, with ball retaining groove
- > Chrome-vanadium steel



Code	No.					
3301344	R38950001	1/4	6.3	62	160	0.120

R3867XXXX

2GT-HANDLE CRANKED WRENCH KEY



in-hex

- > Two-way profile
- > Dual-material handle
- > Blade of chrome-vanadium steel
- > Matt chrome-plated



Code	No.	mm	Blade length 1	Blade length 2	kg
3301274	R38672509	2,5	100	52	0.050
3301275	R38670309	3	100	52	0.044
3301276	R38670409	4	150	52	0.063
3301277	R38670512	5	150	65	0.080
3301278	R38670612	6	150	65	0.108
3301279	R38670814	8	200	75	0.217
3301280	R38671015	10	200	80	0.280

R38672006

2GT-HANDLE CRANKED SOCKET KEY SET



In-hex, 6 pieces

- > Two-way profile
- > Dual-material handle for a hands-friendly transfer of force
- > Blade of chrome-vanadium steel
- > Matt chrome-plated

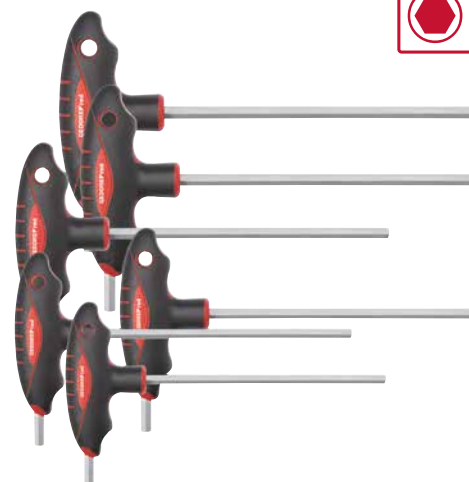

Code	No.	Contents	pieces	kg
3301281	R38672006	Size 2.5 3 4 5 6 8 mm	6	0.731

R3660XXXX

CRANKED SOCKET KEY



in-hex

- > Based on DIN ISO 2936
- > Hardened throughout
- > Chrome-vanadium steel
- > Phosphated



Code	No.	mm	Blade length 1	Blade length 2	kg
3301282	R36601508	1,5	50	16	0.002
3301283	R36600209	2	56	18	0.002
3301284	R36602511	2,5	63	20	0.003
3301285	R36600311	3	70	25	0.004
3301286	R36600413	4	80	28	0.010
3301287	R36600515	5	90	32	0.018
3301288	R36600617	6	95	34	0.030
3301290	R36600819	8	100	36	0.058
3301291	R36601020	10	112	40	0.102

R36605009

CRANKED SOCKET KEY SET



in-hex, 9 pieces

- > Based on DIN ISO 2936
- > Hardened throughout
- > Chrome-vanadium steel
- > Phosphated
- > In the holder



Code	No.	Contents	pieces	
3301331	R36605009	Size 1.5 2 2.5 3 4 5 6 8 10	9	0.250

R36675009

CRANKED SOCKET KEY SET



in-hex, 9 pieces

- > Based on DIN ISO 2936
- > With ball end
- > Hardened throughout
- > Chrome-vanadium steel
- > Phosphated
- > In the holder



Code	No.	Contents	pieces	
3301335	R36675000	Size 1.5 2 2.5 3 4 5 6 8 10	9	0.404

R36405009

CRANKED SOCKET KEY SET



TX, 9 pieces

- > Short version
- > Hardened throughout
- > Chrome-vanadium steel
- > Phosphated
- > In the holder



Code	No.	Contents	pieces	
3301354	R36405009	T10 T15 T20 T25 T27 T30 T40 T45 T50	9	0.240

R3850 XXXX

2C-SOCKET WRENCH



external hex

- > Dual-material handle for a hands-friendly transfer of force
- > With hanging hole
- > Blade matt chrome-plated
- > Chrome-vanadium steel



Code	No.	mm	mm	mm	Ø	kg
3301368	R38500417	4	90	190	6.8	0.065
3301369	R38500517	5	90	190	7.8	0.065
3301370	R38500617	6	90	190	9.8	0.070
3301371	R38500719	7	100	210	10.3	0.090
3301372	R38500819	8	100	210	11.8	0.095
3301373	R38500919	9	100	210	12.8	0.100
3301374	R38501023	10	120	240	13.8	0.100
3301375	R38501123	11	120	240	15.8	0.145
3301376	R38501223	12	120	240	16.8	0.150
3301377	R38501323	13	120	240	17.8	0.155

R3899 0000

(DE)MAGNETISER

- > Magnetises tools and grippers
- > Demagnetises all tools which are used on electronic devices



Code	No.	W	H	D	kg
3301340	R38990000	52	50	29	0.082

Bits 1/4" drive

Bit boxes

R3300 5007

BIT BOX 1/4"



7 pieces

- > Bit box with the usual bit sizes and drive adapter with bit locking
- > Hexagon drive acc. to DIN 3126 ISO 1173 - C 6.3
- > Machine-operated
- > Phosphated
- > In the holder



Code	No.	Contents	pieces	kg
3301345	R33005007	1/4" slotted bits 4 5 6 mm 1/4" cross-head PH 1 2 3 Drive adapter 1/4" hex x 1/4" hex, with magnet	7	0.080

R33005009

BIT BOX 1/4"



9 pieces

- > Bit box with the usual bit sizes and drive adapter with bit locking
- > Hexagon drive acc. to DIN 3126 ISO 1173 - C 6.3
- > Machine-operated
- > Phosphated
- > In the holder



Code	No.	Contents	pieces	
3301346	R33005009	1/4" slotted bits 4 5 6 mm 1/4" cross-head PH 3 4 5 Drive adapter 1/4" hex x 1/4" hex, with magnet	9	0.086

R33005014

BIT BOX 1/4"



14 pieces

- > Bit box with the usual bit sizes and drive adapter with bit locking
- > Hexagon drive acc. to DIN 3126 ISO 1173 - C 6.3
- > Machine-operated
- > Phosphated
- > In the holder



Code	No.	Contents	pieces	
3301347	R33005014	1/4" hexagon bits, size 3 4 5 mm 1/4" slotted bits 4 5 6 mm 1/4" cross-head bits PH 1 2 3 1/4" TX bits T10 T15 T20 T25 Drive adapter 1/4" hex x 1/4" hex, with magnet	14	0.110

R33005031

BIT BOX 1/4"



32 pieces

- > Large Bit box with usual bit sizes
- > Drive adapter with magnetic bit locking
- > Hexagon drive acc. to DIN 3126 ISO 1173 - C 6.3
- > Machine-operated
- > Phosphated
- > In clearly arranged plastic box



Code	No.	Contents	pieces	
3301338	R33005031	In-hex 3 4 5 Slotted 0.6x4.5 1.0x5.5 1.2x6.5 2 of each: Cross-head PH 1 2 3 Cross-head PZ 1 2 3 TX T10 T15 T20 T25 T30 T40 Quick change adaptor for 1/4" bits C 6.3 with magnet Bit adapter 1/4" hex x 1/4" square	32	0.250

Impact-type screw remover

R3800 4006
SCREW REMOVER SET

6 pieces

- > Hammer-actuating screw remover, for extracting stiff screws
- > Clockwise/anticlockwise rotating direction, reversible
- > 1/2" square drive in acc. with DIN 3120 - A 12.5, ISO 1174, with ball locking device for sockets
- > 1/2" adapter, snap-on with hex recess drive in acc. with DIN 3126 - D 8 (5/16") with retention spring for bits
- > In robust sheet-metal case



Code	No.	Contents	pieces	
3301399	R38004006	Bit adapter 1/2" square on 5 1/6" hex recess 5/16" slotted bit 6 8 mm 5/16" cross-head PH 2 3	6	1.022

Bits 10mm drive

Bit sets

R3500 3040
BIT SET 10 MM SK / XZN / TX

40 pieces

- > Reinforced bits, 10 mm
- > Hand-operated
- > Hexagon drive acc. to DIN 3126 ISO 1173 - C 10
- > Bit adapter female square drive 1/2" on hex recess mounting 10mm
- > Bit adapter female square drive 3/8" on hex recess mounting 10mm
- > In rugged plastic case



Code	No.	Contents	pieces	
3301572	R35003040	Hex recess bit, size 4 5 6 8 10 12 30 mm Hex recess bit, size 4 5 6 8 10 12 75 mm TX Bit T20 T25 T30 T40 T45 T50 T55 30 mm TX Bit T20 T25 T30 T40 T45 T50 T55 75 mm XZN-Bit M5 M6 M8 M10 M12 30 mm XZN-Bit M5 M6 M8 M10 M12 75 mm Bit adapter female square drive 1/2" on hex recess mounting 10mm Bit adapter female square drive 3/8" on hex recess mounting 10mm	40	1.750

PLIERS

138 - 145



Pliers

R2830XXXX

COMBINATION PLIERS



- > Acc. to DIN ISO 5746
- > Gripping zones for flat and round stock
- > Induction-hardened cutting edges
- > Dual-material handle for a hands-friendly transfer of force
- > Chrome-vanadium steel



Code	No.	Hard wire Ø mm	l mm	kg
3301124	R28302180	1,6	180	0.240
3301125	R28302200	1,8	200	0.305

R2842XXXX

POWER SIDE CUTTER



- > Acc. to DIN ISO 5749
- > High cutting performance with little force applied
- > Slim head
- > Induction-hardened long cutting edges
- > Dual-material handle for a hands-friendly transfer of force
- > Chrome-vanadium steel



Code	No.	Piano wire Ø mm	l mm	kg
3301127	R28422180	1,8	180	0.230
3301128	R28422200	2,0	200	0.320

R28402160

SIDE CUTTER



- > Acc. to DIN ISO 5749
- > Slim head
- > Induction-hardened long cutting edges
- > Dual-material handle for a hands-friendly transfer of force
- > Chrome-vanadium steel



Code	No.	Hard wire Ø mm	l mm	kg
3301130	R28402160	1,6	160	0.191

R2850XXXX

BENT NOSE TELEPHONE PLIERS



straight

- > Acc. to DIN ISO 5745
- > Straight grip surfaces, lengthways-serrated
- > Induction-hardened cutting edges
- > Dual-material handle for a hands-friendly transfer of force
- > Chrome-vanadium steel



Code	No.	Hard wire Ø mm	l mm	kg
3301131	R28502160	1,6	160	0.150
3301133	R28502200	1,8	200	0.200

R2851 XXXX

BENT NOSE TELEPHONE PLIERS



45° angle

- > Acc. to DIN ISO 5745
- > 45% angled grip surfaces, lengthways-serrated
- > Induction-hardened cutting edges
- > Dual-material handle for a hands-friendly transfer of force
- > Chrome-vanadium steel



Code	No.	Hard wire Ø mm	l mm	kg
3301134	R28512160	1,6	160	0.166
3301136	R28512200	1,8	200	0.220

R2820 2176

STRIPPING PLIERS



- > Opening stop with adjustment screw and spring
- > Dual-material handle for a hands-friendly transfer of force
- > Special tool steel, forged



Code	No.	Strips wires	l mm	kg
3301844	R28022176	10 mm ² AWG 7	175	0.190

R2800 2003

PLIERS SET



3 pieces

- > Induction-hardened cutting edges
- > Dual-material handles for a hands-friendly transfer of force
- > Chrome-vanadium steel



Code	No.	Contents	pieces	kg
3301155	R28002003	Combination pliers 180 mm Side cutter 160 mm Telephone pliers, straight 200 mm	3	0.711

R2890 4201

PINCER

- > Acc. to DIN ISO 9243
- > Head ground
- > Standard heavy-duty pincers
- > Induction-hardened cutting edges
- > Dip-coated handle covers
- > Special tool steel, forged



Code	No.	Medium-hard wire Ø mm	l mm	kg
3301874	R28904201	2,0	200	0.375

R2892XXXX TOWER PINCER

- > Acc. to DIN ISO 9242
- > Head ground
- > Standard heavy-duty pincers
- > Induction-hardened cutting edges
- > Dip-coated handle covers
- > Special tool steel, forged



Code	No.	Medium-hard wire Ø mm	l mm	kg
3301842	R28924110	2,4	250	0.395
3301843	R28924112	3,1	300	0.550

R2880XXXX BOLT CUTTERS

- > Induction-hardened, phosphated precision cutting edges
- > Angled tubular steel leg for ease of use
- > Ergonomically formed 1-component handles
- > High quality tempered special steel

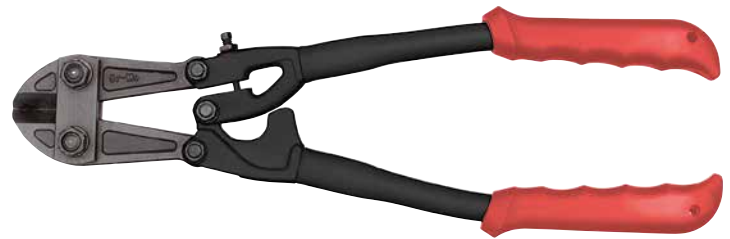

Code	No.	Cutting capacity HRC 19 Ø mm	Cutting capacity HRC 40 Ø mm	l mm	kg
3301150	R28801018	8	6	450	1.400
3301151	R28801024	9	8	600	2.500
3301152	R28801030	11	9	750	3.900
3301153	R28801036	13	10	900	5.900

Circlip pliers

R2760XXXX CIRCLIP PLIERS FOR EXTERNAL RETAINING RINGS

straight

- > Acc. to DIN 5254, Form A
- > Straight precision tips
- > With opening spring
- > DIN 471 for retaining rings
- > DIN 983 for shaft diameter
- > Dip-coated handle covers
- > Chrome-vanadium steel



Code	No.	Size	Tip-Ø	Ring-Ø	kg
3301137	R27604025	A1	1.3	10.0	0.098
3301138	R27604060	A2	1.8	19.0	0.180
3301139	R27604100	A3	2.3	40.0	0.234

R2765XXXXCIRCLIP PLIERS FOR
EXTERNAL RETAINING RINGS

angled

- > Acc. to DIN 5254, Form B
- > 90° precision tips
- > With opening spring
- > DIN 471 for retaining rings
- > DIN 983 for shaft diameter
- > Dip-coated handle covers
- > Chrome-vanadium steel



Code	No.	Size	Tip-Ø	Ring-Ø	
3301140	R27654025	A11	1.3	10.0	0.097
3301141	R27654060	A21	1.8	19.0	0.160
3301142	R27654100	A31	2.3	40.0	0.230

R2770XXXXCIRCLIP PLIERS FOR
INTERNAL RETAINING RINGS

straight

- > Acc. to DIN 5256 Form C
- > Straight precision tips
- > DIN 472 for retaining rings
- > DIN 984 for drill hole diameter
- > Dip-coated handle covers
- > Chrome-vanadium steel



Code	No.	Size	Tip-Ø	Ring-Ø	
3301143	R27704025	J1	1.3	12.0	0.081
3301144	R27704060	J2	1.8	19.0	0.150
3301145	R27704100	J3	2.3	40.0	0.208

R2775XXXXCIRCLIP PLIERS FOR
INTERNAL RETAINING RINGS

angled

- > Acc. to DIN 5256 Form D
- > 90° precision tips
- > DIN 472 for retaining rings
- > DIN 984 for drill hole diameter
- > Dip-coated handle covers
- > Chrome-vanadium steel



Code	No.	Size	Tip-Ø	Ring-Ø	
3301146	R27754025	J11	1.3	12.0	0.082
3301147	R27754060	J21	1.8	19.0	0.150
3301148	R27754100	J31	2.3	40.0	0.208

R28002004 CIRCLIP PLIERS SET

straight, 4 pieces

- > Circlip pliers for external retaining rings, straight and angled, Size 2
- > Circlip pliers for internal retaining rings, straight and angled, Size 2
- > Dip-coated handle covers
- > Chrome-vanadium steel



Code	No.	Contents	pieces	
3301156	R28002004	External circlip pliers straight A2 External circlip pliers angled A21 Internal circlip pliers straight J2 Internal circlip pliers angled J21	4	0.680

Pipe/water pump pliers

R2710XXXX PIPE WRENCH

Swedish pattern

- > Acc. to DIN 5234
- > Solid type
- > 90° jaw set
- > Teeth offset against direction of rotation
- > Jaws polished
- > Secure knurled nut
- > Chrome-vanadium steel



Code	No.	"inch	mm	↳ mm	
3301157	R27100010	1	40	320	0.780
3301158	R27100015	1.1/2	55	420	1.356
3301159	R27100020	2	67	555	2.550
3301160	R27100030	3	103	635	3.100

R2714XXXX PIPE WRENCH

S-jaw

- > Acc. to DIN 5234
- > Solid type
- > 45° jaw set
- > Teeth offset against direction of rotation
- > Jaws polished
- > Secure knurled nut
- > Chrome-vanadium steel



Code	No.	"inch	mm	↳ mm	
3301167	R27140010	1	40	325	0.800
3301168	R27140015	1.1/2	55	420	1.460
3301169	R27140020	2	67	535	2.500
3301170	R27140030	3	103	640	4.220

R2716XXXX

PIPE WRENCH

American pattern

- > Stillson type
- > Hardened knurled nut fixes span width
- > Hole for hanging up
- > Forged steel



Code	No.	inch	mm	inch	mm	
3301203	R27160007	1.1/2	38	8	200	0.400
3301204	R27160009	1.7/8	43	10	250	0.800
3301205	R27160011	2.1/8	53	12	300	1.000
3301206	R27160012	2.3/8	58	14	350	1.400
3301207	R27160016	3	76	18	450	2.100
3301208	R27160021	3.1/2	89	24	600	3.500
3301209	R27160030	5.1/2	140	36	900	7.900

R2810XXXX

WATER PUMP PLIERS



7 settings

- > Acc. to DIN 8976 Form C
- > Lengthways-serrated grip surfaces
- > With box joint
- > 7 settings
- > Head and joint polished
- > Chrome-vanadium steel
- > Red powder-coating



Code	No.	mm	inch	mm	
3301174	R28100007	25	7	175	0.160
3301175	R28100010	33	10	250	0.300
3301176	R28100012	42	12	300	0.406

R28154010

WATER PUMP PLIERS



- > Acc. to DIN 8976
- > Automatic setting mechanism for one-handed operation
- > Safety-box joint, substantial stability from a double guide
- > Slender design eases access to workpiece
- > Lengthways-serrated grip surfaces
- > Head polished
- > Dip-coated handle covers
- > Chrome-vanadium steel



Code	No.	mm	inch	mm	
3301172	R28154010	35	10	250	0.374

Locking pliers

R2720XXXX
LOCKING PLIERS



- > For clamping and gripping profile sections, round and flat stock
- > Lengthways-serrated grip surfaces
- > Adjustment screw and release lever
- > One-handed operation
- > Surface chrome-plated
- > Chrome-vanadium steel



Code	No.	mm	inch	mm	
3301177	R27200007	35	7	185	0.375
3301178	R27200010	40	10	225	0.545
3301179	R27200012	60	12	295	0.910

R27202003
CURVED JAW LOCKING PLIERS SET



- > For clamping and gripping profiled, round and flat-section material
- > Lengthways-serrated grip surfaces
- > Adjustment screw and release lever
- > One-handed operation
- > Surface chrome-plated
- > Chrome-vanadium steel



Code	No.	Contents	pieces	
3301180	R27202003	Length 7" 10" 12"	3	1.950

R27220065
LONG NOSE LOCKING PLIERS



- > For clamping and gripping profiled, round and flat-section material
- > Long jaws for difficult-to-reach and tight spots
- > Lengthways-serrated grip surfaces
- > Adjustment screw and release lever
- > One-handed operation
- > Surface chrome-plated
- > Chrome-vanadium steel



Code	No.	mm	inch	mm	
3301181	R27220065	50	6,5	175	0.175

VICES

146 - 147



R9380 0125

VICE

rigid

- > Centric guidance for absolutely parallel clamping
- > Vice opening to the front
- > Precise guidance
- > With anvil
- > Max. clamping force 25 kN
- > Cast-iron



Code	No.	Type	mm	mm	kg
3301737	R93800125	rigid	125	125	19.0

R9380 0150

VICE

with rotary plate

- > Centric guidance for absolutely parallel clamping
- > Vice opening to the front
- > Chuck for 13.5 - 56 mm diameter pipes
- > Precise guidance
- > With anvil
- > Max. clamping force 25 kN
- > Cast-iron

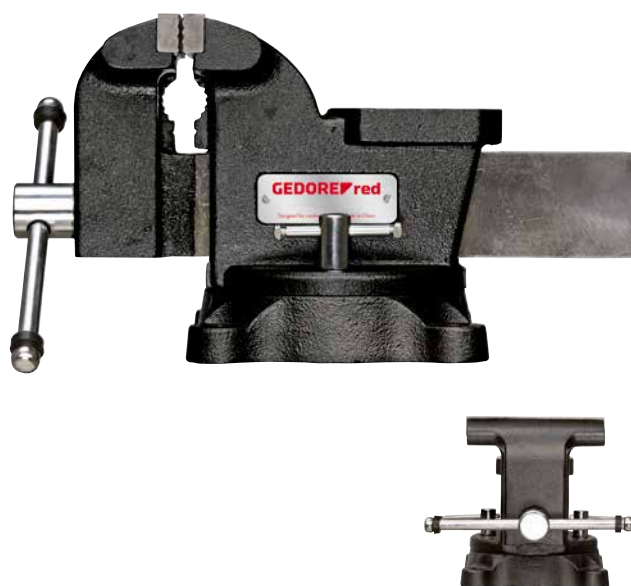

Code	No.	Type	mm	mm	kg
3301738	R93800150	with rotary plate	150	125	14.0

STRIKING TOOLS

148-157





Hammers

R9210XXXX

ENGINEERS' HAMMER

- > Drop-forged hammer head, black paint-finished, of heat-treated steel
- > Striking surfaces inductively case-hardened for tough long-term work
- > Acc. to DIN 1041
- > DIN, manufacturer and weight marked for permanence
- > Safety bevel precision-ground to 45° at striking face and pein
- > Contoured ash handle
- > Paint-finished handle end improves the surface feel
- > 360° clamping force of the tapered collar fixes the hammer head





Code	No.	g 	l mm 	kg 
3300710	R92100004	100	260	0.170
3300711	R92100008	200	280	0.264
3300712	R92100012	300	300	0.432
3300713	R92100016	400	300	0.565
3300714	R92100020	500	320	0.622
3300715	R92100032	800	350	0.950
3300716	R92100040	1000	360	1.164
3300717	R92100055	1500	380	1.720
3300718	R92100065	2000	400	2.200

R9212XXXX

ENGINEERS' HAMMER

- > Drop-forged hammer head, black paint-finished, of heat-treated steel
- > Striking surfaces inductively case-hardened for tough long-term work
- > Acc. to DIN 1041
- > DIN, manufacturer and weight marked for permanence
- > Practically unbreakable fibre glass handle



Code	No.	g 	l mm 	kg 
3300720	R92120012	300	300	0.480
3300722	R92120020	500	320	0.730
3300723	R92120032	800	350	1.100

R9220XXXX CLUB HAMMER

- › Drop-forged hammer head, black paint-finished, of heat-treated steel
- › Striking surfaces inductively case-hardened for tough long-term work
- › Acc. to DIN 6475
- › DIN, manufacturer and weight marked for permanence
- › Safety bevel precision-ground to 45° at striking face
- › Contoured ash handle
- › Paint-finished handle end improves the surface feel
- › 360° clamping force of the tapered collar fixes the hammer head



Code	No.	g	↳ mm	↕ kg
3300725	R92200040	1000	260	1.164
3300726	R92200050	1250	260	1.350
3300727	R92200055	1500	280	1.690
3300728	R92200065	2000	300	2.110
3300729	R92200083	5000	810	5.500

R9230 0083 SLEDGE HAMMER

- › Drop-forged hammer head, black paint-finished, of heat-treated steel
- › Striking surfaces inductively case-hardened for tough long-term work
- › Acc. to DIN 1042
- › DIN, manufacturer and weight marked for permanence
- › Safety bevel precision-ground to 45° at striking face
- › Ash handle
- › 360° clamping force of the tapered collar fixes the hammer head



Code	No.	g	↳ mm	↕ kg
3300737	R92300083	5000	800	5.894

R9250XXXX RUBBER HAMMER

- › Hammer head of hard rubber
- › Acc. to DIN 5128-90
- › With two flat striking surfaces
- › Straight ash handle
- › Paint-finished handle end improves the surface feel



Code	No.	∅ mm	↳ mm	↕ kg
3300738	R92500048	48	315	0.370
3300739	R92500058	58	315	0.520

R9250XXXX

RUBBER HAMMER

- > Hammer head of hard rubber
- > 1 crowned face and a striking face
- > Straight ash handle



Code	No.	Ø mm	l- mm -l	kg
3300740	R92500163	63	330	0.580
3300741	R92500179	79	360	0.920

R9260 0030

NYLON HAMMER

- > Exchangeable heads made from impact-resistant nylon
- > Straight ash handle



Code	No.	Description	Ø mm	l- mm -l	kg
3300744	R92600030	Nylon hammer head D.30mm L.280mm ash	30	280	0.300
3300746	R92950030	Spare head D.30mm nylon f.recoilless hammer	30		0.036

R9216XXXX

MACHINISTS' HAMMER

- > Drop-forged hammer head of heat-treated steel
- > Precision-like ground striking face and ball
- > Contoured hickory handle
- > 360° clamping force of the tapered collar fixes the hammer head



Code	No.	lbs	g	l- mm -l	kg
3300766	R92160002	1/4	113	255	0.176
3300767	R92160003	1/2	227	290	0.340
3300768	R92160004	3/4	340	310	0.470
3300769	R92160005	1	453	330	0.940
3300770	R92160008	1.1/2	680	350	0.920
3300771	R92160010	2	907	390	1.060

R9242 0023

CLAW HAMMER, AMERICAN PATTERN

- > Forged type from special steel
- > Pein with nail extractor
- > Striking face and pein polished
- > Rounded edges
- > Practically unbreakable fibreglass handle with plastic grip



Code	No.	Ø mm	g	oz	lbs	l mm	kg
3300782	R92420023	27	570	20	1.1/4	340	0.800

R9243 0023

CLAW HAMMER, AMERICAN PATTERN

- > Forged type from special steel
- > Pein with nail extractor
- > Striking face and pein polished
- > Rounded edges
- > Tubular steel handle with plastic grip



Code	No.	Ø mm	g	oz	lbs	l mm	kg
3300783	R92430023	27	570	20	1.1/4	320	0.830

R9240 2024

CARPENTER'S HAMMER

- > Forged type, black paint-finished, from special steel
- > Rounded edges
- > Pein with magnetic nail groove
- > Tubular steel handle with plastic grip
- > Secured head



Code	No.	g	oz	lbs	l mm	kg
3300784	R92402024	600	21	1.1/4	330	0.880

Chisels / Punches

R91990000
PROTECTIVE HAND GUARD

For chisel

- > Impact-resistant plastic
- > Avoids injuries of the hand
- > No rolling away (rectangular shape)
- > Oil-proof



Code	No.	oval	octagonal	↳ mm ↲	⚖
3300827	R91990000	20x12 - 26x13 mm	16 - 20 mm	120	0.134

R9114XXXX
FLAT CHISEL

flat oval

- > Acc. to DIN 6453
- > Cutting edge and head ground
- > Striking end tempered
- > Shaft copper, tip paint-coated in silver
- > Made from chrome-vanadium steel



Code	No.	mm ↲	Shaft thickness	↳ mm ↲	⚖
3300785	R91140016	15	9	125	0.100
3300786	R91140021	18	11	150	0.180
3300787	R91140026	21	12	175	0.280
3300788	R91140031	24	13	200	0.400
3300789	R91140041	25	13	250	0.500
3300790	R91140051	26	13	300	0.600

R9125XXXX
BRICKLAYER'S CHISEL

octagonal

- > Acc. to DIN 7254, Form B
- > Cutting edge and head ground
- > Striking end tempered
- > Shaft copper, tip paint-coated in silver
- > Made from chrome-vanadium steel



Code	No.	mm ↲	octagonal	↳ mm ↲	⚖
3300791	R91250041	23	16	250	0.400
3300792	R91250051	23	16	300	0.470
3300793	R91250056	26	18	350	0.700
3300794	R91250061	26	18	400	0.791

R9129XXX

BRICKLAYER'S CHISEL



flat oval

- > Acc. to DIN 7254, Form A
- > Cutting edge and head ground
- > Striking end tempered
- > Shaft copper, tip paint-coated in silver
- > Made from chrome-vanadium steel



Code	No.	mm	octagonal	l mm	
3300795	R91290041	26	12	250	0.400
3300796	R91290051	29	13	300	0.600
3300797	R91290056	29	13	350	0.702

R9149 0016

CROSS-CUT CHISEL



flat oval

- > Acc. to DIN 6451
- > Cutting edge, sides and head ground
- > Striking end tempered
- > Shaft copper, tip paint-coated in silver
- > Made from chrome-vanadium steel



Code	No.	mm	Shaft thickness	l mm	
3300799	R91490016	5	9	125	0.100
3300800	R91490021	6	11	150	0.170

R91370039

SPLITTING CHISEL



flat

- > Cutting edge and head ground
- > Striking end tempered
- > Shaft copper, tip paint-coated in silver
- > Made from chrome-vanadium steel



Code	No.	mm	Shaft thickness	l mm	
3300802	R91370039	26	4	240	0.260

R9140XXXX

POINT CHISEL

octagonal

- > Acc. to DIN 7256
- > Cutting edge and head ground
- > Striking end tempered
- > Shaft copper, tip paint-coated in silver
- > Made from chrome-vanadium steel



Code	No.	octagonal	l- mm -l	
3300803	R91400041	16	250	0.380
3300804	R91400051	16	300	0.460
3300805	R91400056	18	350	0.700
3300806	R91400061	18	400	0.805



R91310041

ELECTRICIANS' CHISEL

square

- > For mortising slots, working on masonry, cutting wood and plasterboard
- > Cutting edge and head ground
- > Striking end tempered
- > Shaft copper, tip paint-coated in silver
- > Made from chrome-vanadium steel



Code	No.	mm 	square	l- mm -l	
3300807	R91310041	8	6	250	0.064

R9020XXXX

PIN PUNCH

octagonal

- > Acc. to DIN 6450
- > Striking end tempered
- > Shaft copper, tip paint-coated in silver
- > Made from chrome-vanadium steel



Code	No.	Tip diameter	Shaft diameter	l- mm -l	
3300808	R90200221	2	10	150	0.065
3300809	R90200321	3	10	150	0.065
3300810	R90200421	4	10	150	0.065
3300811	R90200521	5	10	150	0.065
3300812	R90200621	6	10	150	0.075
3300813	R90200721	7	12	150	0.105
3300814	R90200821	8	12	150	0.110
3300815	R90201021	10	12	150	0.125

R9010XXXX DRIFT PUNCH



octagonal

- > Acc. to DIN 6458
- > Striking end tempered
- > Shaft copper, tip paint-coated in silver
- > Made from chrome-vanadium steel



Code	No.	Tip diameter	Shaft diameter	↳ mm ↳	
3300816	R90100115	1	10	120	0.060
3300817	R90100215	2	10	120	0.060
3300818	R90100315	3	10	120	0.060
3300819	R90100415	4	12	120	0.090
3300820	R90100515	5	12	120	0.090

R9015XXXX CENTRE PUNCH



octagonal

- > Acc. to DIN 7250
- > Striking end tempered
- > Shaft copper, tip paint-coated in silver
- > Made from chrome-vanadium steel

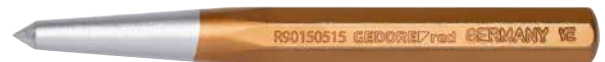

Code	No.	Ø	Shaft diameter	↳ mm ↳	
3300821	R90150415	4	10	120	0.080
3300822	R90150515	5	12	120	0.095

R91901004 PROTECTING CHISEL SET

4 pieces

- > For completing decorative and window rails in a paint-saving manner
- > For the removal of adhesive weights on aluminium rims
- > Flexible chisel blades
- > Striking cap for light strikes
- > Ergonomic handle
- > Made of special plastic



Code	No.	Blade width	↳ mm ↳	pieces	
3301570	R91901004	3/4" 19 mm 7/8" 22 mm 1" 26 mm 1.1/2" 38 mm	275	4	0.525

Sets

R9020XXX PIN PUNCH SET

6 pieces

- > Acc. to DIN 6450
- > Striking ends tempered
- > Shaft copper, tip paint-coated in silver
- > Made from chrome-vanadium steel
- > In metal case with lid



R90200106



R90200006



Code	No.	Contents	pieces	kg
3300823	R90200006	Ø 3 4 5 6 7 8 mm	6	0.800
3300824	R90200106	Ø 3 4 5 6 8 10 mm	6	0.820

R9010 0006 DRIFT PUNCH SET

6 pieces

- > Acc. to DIN 6458 and DIN 7250
- > Striking ends tempered
- > Shaft copper, tip paint-coated in silver
- > Made from chrome-vanadium steel
- > In metal case with lid



Code	No.	Contents	pieces	kg
3300825	R90100006	Drift punches Ø 1 2 3 5 10 mm Centre punch Ø 4 mm	6	0.720

R9000 0006 STRIKING TOOL SET

6 pieces

- > Striking ends tempered
- > Shaft copper, tip paint-coated in silver
- > Made from chrome-vanadium steel
- > In metal case with lid



Code	No.	Contents	pieces	kg
3300826	R90000006	Flat cold chisel, length 125 mm 150 mm Cross-cut chisel, length 125 mm Drift punch Ø 3 mm Centre punch Ø 4 mm Pin punch Ø 4 mm	6	0.820

MEASURING / MARKING

158 - 161



Spirit levels

R9410XXXX SPIRIT LEVEL

- > Smooth aluminium rectangular profile
- > One vertical and one horizontal vial, acrylic glass, plexiglass
- > Measurement accuracy: +/- 0.5 mm/m
- > Red powder-coating
- > End caps of black, impact-resistant plastic
- > Hanging hole



Code	No.	l<mm>l	kg
3301422	R94100051	300	0.170
3301436	R94100075	600	0.260
3301423	R94100087	1000	0.480

R9410XXXX SPIRIT LEVEL

with a movable vial, magnetic

- > Smooth aluminium rectangular profile
- > One vertical and one horizontal vial
- > Also with a third, rotating angle spirit level for ease in measuring an angle
- > Magnetic
- > Measurement accuracy: +/- 0.5 mm/m
- > Brushed aluminium
- > End caps of black, impact-resistant plastic
- > Hanging hole



Code	No.	l<mm>l	kg
3301424	R94100151	300	0.170
3301425	R94100187	1000	0.482

Measuring

R9450 0002 WOOD SECTIONED FOLDING RULER

- > With easy to read metric dual scale
- > Accuracy class III
- > EG-design approval for continuous mm graduation
- > Beech wood with through-riveted joints



Code	No.	↳ mm ↳	
3301426	R94500002	2000	0.086

R9455 XXXX TAPE MEASURE

- > Housing from 2-component ABS, fitted out with metal clip
- > Nylon-coated tape measure, abrasion resistant, waterproof, yellow paint finish
- > mm-graduation in black
- > Decimals highlighted in red
- > Automatic tape rewind and lock
- > Magnetic stop
- > Accuracy class II





Code	No.	L m	mm	
3301427	R94550003	3	19	0.201
3301428	R94550005	5	19	0.265
3301429	R94550008	8	25	0.468

Gauges

R9442 0021 DIGITAL MEASURING CALLIPER

- > Large LCD display 30 x 10 mm, automatic shutdown
- > Reset-adjustment possible at any position
- > For outdoor, interior, stepped and depth gauging
- > Precision roller adjustment
- > mm/inch switch-over
- > With inside and outside jaws
- > Ground tips
- > In sturdy plastic case incl. spare battery
- > Operating instructions
- > Connection to PC interface
- > Adjusting screw for measured value fixing
- > Thread chart on the back





Code	No.	mm 	"inch 	
3301430	R94420021	153	6	0.340

R9465 0013

FEELER GAUGE SET

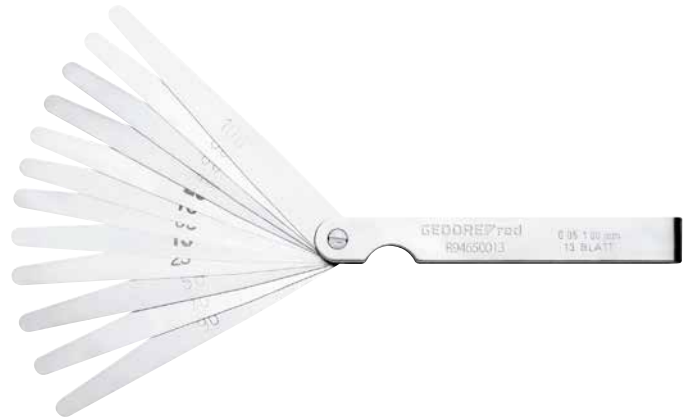
- › With protective handle, folding
- › For checking in-between spaces, contact intervals etc.
- › Blades tapering to a cone
- › Made of hardened spring steel
- › Individually labelled with details of sizes



Code	No.		
3301431	R94650013	5 10 15 20 25 30 40 50 60 70 80 90 100/100	0.100

Marking

R9095 0012

PENCIL

Value pack

- › For drawing and marking on practically all materials
- › Oval form stops them rolling off when put down



Code	No.	« mm »	pieces	
3301432	R90950012	175	12	0.020

R9090 0020

CARBIDE SCRIBER WITH CLIP

- › Pencil and carbide scriber in one
- › Straight
- › Retractable nib
- › For drawing and marking on metallic and similar surfaces
- › Metal housing
- › Attaching clip



Code	No.	« mm »	
3301433	R90900020	150	0.020

CUTTING / FILING / DRILLING

162 - 171



Cutting

R9321XXXX
HEAVY-DUTY UTILITY KNIFE

- > Multi-component handle
- > Aluminium housing
- > Quick-change mechanism
- > One-handed operation
- > For right and left-handers
- > Supplied with 1 trapezoid blade and 4 spare trapezoid blades
- > Blade cartridge
- > Sturdy design



Code	No.	Description	l mm	kg
3301598	R93210000	Heavy-duty utility knife 5blades Multiple C handle	165	0.310
3301599	R93960000	Trapezoid blades f.Cutter No.R93210000		0.040
3301600	R93960100	Hooked blades f.Cutter No.R93210000		0.050

R9320XXXX
UTILITY KNIFE

- > Blade 9 mm wide
- > Plastic housing
- > Metal blade guide
- > One-handed operation
- > For right-handers
- > Supplied with 5 spare blades (80mm long, 0.4mm thick)
- > Blade cartridge



Code	No.	Description	l mm	mm	kg
3301601	R93200010	Utility knife 5blades-B.9mm	145	9	0.068
3301602	R93950010	Spare break-off blades B.9mm 10pcs		9	0.030

R9320XXXX

UTILITY KNIFE



- > Blade 18 mm wide
- > Plastic housing
- > Metal blade guide
- > One-handed operation
- > For right-handers
- > Supplied with 5 spare blades (100mm long, 0.4mm thick)
- > Blade cartridge
- > With built-in sharpener



Code	No.	Description		- mm	
3301603	R93200018	Utility knife 5blades-B.18mm + sharpener	175	18	0.160
3301604	R93950018	Spare break-off blades B.18mm 10pcs		18	0.088

R9320XXXX

UTILITY KNIFE



- > Practical belt clip
- > Blade 25 mm wide
- > Plastic housing
- > Metal blade guide
- > One-handed operation
- > For right-handers
- > Supplied with 5 spare blades (125mm long, 0.5mm thick)
- > Blade cartridge



Code	No.	Description		- mm	
3301605	R93200025	Utility knife 5blades-B.25mm w. clip	205	25	0.280
3301606	R93950025	Spare break-off blades B.25mm 10pcs		25	0.170

R9325 0008

POCKET KNIFE

- > Two-handed operation knife
- > Secure in pocket and on belt; cannot be accidentally opened
- > Blade locking feature
- > Coated blade
- > With sawing function for fibrous materials e.g ropes and textiles
- > Practical belt clip
- > Dual-material handle, for easy handling
- > Handle loop for safeguarding





Code	No.			
3301615	R93250008	87	210	0.154

R9330 0031

UNIVERSAL SCISSORS

- > Suitable for cutting seals and other materials (paper, cardboard, plastic, leather etc.)
- > Additional small blade for thin wires and cables
- > With wire stripper for 1.0, 1.5 and 2.0 mm cables in the handle
- > For right and left-handers
- > Locking lever
- > Dual-material handle, for easy handling
- > Blade of stainless steel



Code	No.		l< mm >l	
3301607	R93300031	50	205	0.190

R9331 XXXX

IDEAL PATTERN SNIPS

- > Self-opening with installed spring, with lock
- > Induction-hardened precision cutting edges
- > Dual-material handle, for easy handling
- > Made of special tool steel



R93310041



R93310141



R93310241

Code	No.	Model	l< inch >l	l< mm >l	
3301741	R93310041	right hand cutting	10	250	0.410
3301742	R93310141	straight cutting	10	250	0.410
3301743	R93310241	left hand cutting	10	250	0.410

R9980 0000

MULTIFUNCTION TOOL

- > Stainless steel
- > Blade locking feature
- > Ergonomic handle, for easy handling



Code	No.	
3301757	R99800000	0.210

Saws

R9335 0051

MULTIFUNCTION SAW

**Multifunctional:**

- > Saw blade and bow can be turned through 90° = saw blade parallel to the wall and floor
- > Bow can be turned through 180° = low height for use in tight spaces
- > Very lightweight
- > Hand protection
- > Dual-material handle, for easy handling
- > Supplied with HSS bi-metal saw blade (24 tpi)



Code	No.	↳ mm ↳	⚖
3301608	R93350051	300	0.470

R9335 XXXX

HACKSAW

- > Aluminium
- > Black plastic handle
- > Easy to tension and adjust
- > Supplied with universal saw blade





Code	No.	Description	↳ mm ↳	⚖
3301609	R93350021	Hacksaw blade-L.150mm Alu.	150	0.220
3301610	R93990021	Saw blade L.150mm f.saw No. R93350021	150	0.012

Files

R931XXXX FILES

- > Acc. to DIN 7261 Form B, C, D, E, F
- > Dual-material handle, for easy handling
- > Hanging hole
- > Made from special steel





Code	No.	Description	Model	Cut	 mm	 mm	 kg
3301591	R93100052	Three-edged file with cut L.310mm 2C-handle	▲	2	200	310	0.184
3301592	R93120052	Flat file with cut 2 L.310mm 2C-handle	■	2	200	310	0.192
3301593	R93140052	Round file with cut 2 L.310mm 2C-handle	●	2	200	310	0.124
3301594	R93160052	Half-round file with cut 2 L.310mm 2C-handle	◐	2	200	310	0.190
3301595	R93180052	Square file with cut 2 L.310mm 2K-handle	■	2	200	310	0.124

R9300005 FILE SET

5 pieces

- > Acc. to DIN 7261 Form B, C, D, E, F
- > Dual-material handle, for easy handling
- > Hanging hole
- > Made from special steel
- > In plastic bag





Code	No.	Contents	Model	Cut	 mm	 mm	pieces	 kg
3301597	R93000005	Three-edged file Flat file Round file Half-round file Square file	▲ ■ ● ◐ ■	2	200	310	5	0.820

R9300006 KEY FILE SET

6 pieces

- > With wooden handles
- > Made from special steel



Code	No.	Contents	Model	 mm	 mm	pieces	 kg
3301596	R93000006	Three-edged file Flat file Flat tip file Round file Half-round file Square file	▲ ■ ■ ● ◐ ■	100	177	6	0.850

Wire brushes

R93700043

WIRE BRUSH

with wooden handle



Code	No.	Model	↳ mm ↵	
3301785	R93700043	3-row	260	0.085

R93710043

WIRE BRUSH

with plastic handle

› carbon bristles



Code	No.			
3301786	R93710043			0.095

R93710143

WIRE BRUSH

with plastic handle

› carbon bristles



Code	No.	Model		
3301787	R93710143	3-row		0.120

Drilling

R9350 0025

TWIST DRILL BIT SET, ROLLED



25 pieces

- > HSS Twist drill bit DIN 338, Type N
- > Right hand cutting
- > Tip angle: 118°
- > Heavy-duty steel
- > Black, steam-annealed surface
- > In a sheet steel case
- > Rugged hinges



Code	No.	Contents	pieces	
3301611	R93500025	1.0 1.5 2.0 2.5 3.0 3.5 4.0 4.5 5.0 5.5 6.0 6.5 7.0 7.5 8.0 8.5 9.0 9.5 10.0 10.5 11.0 11.5 12.0 12.5 13.0 mm	25	1.263

R9351 0025

TWIST DRILL BIT SET, BLANK



25 pieces

- > HSS Twist drill bit DIN 338, Type N
- > Right hand cutting
- > Tip angle: 118°
- > Heavy-duty steel
- > True running
- > Bright-finished surface
- > In a sheet steel case
- > Rugged hinges



Code	No.	Contents	pieces	
3301613	R93510025	1.0 1.5 2.0 2.5 3.0 3.5 4.0 4.5 5.0 5.5 6.0 6.5 7.0 7.5 8.0 8.5 9.0 9.5 10.0 10.5 11.0 11.5 12.0 12.5 13.0 mm	25	1.263

R9350 0170

TWIST DRILL BIT SET, ROLLED



170 pieces

- > HSS Twist drill bit DIN 338, Type N
- > Right hand cutting
- > Tip angle: 118°
- > Heavy-duty steel
- > Black, steam-annealed surface
- > In metal assortment box with plastic insert
- > Rugged hinges



Code	No.	Contents	pieces	
3301612	R93500170	In each instance 10x 1.0 1.5 2.0 2.5 3.0 3.5 4.0 4.5 5.0 5.5 6.0 6.5 7.0 7.5 8.0 mm In each instance 5x 8.5 9.0 9.5 10.0 mm	170	3.724

R9355 0017

SDS MASONRY DRILL BIT SET

17 pieces

- > For drilling, cutting, demolition and breaching work in masonry and concrete
- > Carbide hammer drill bits and chisels
- > SDS-plus holder
- > Made of high-grade steel for extra long service lives
- > In metal assortment box with plastic insert
- > Rugged hinges



Code	No.	Contents	pieces	
3301614	R93550017	1 of each: Carbide hammer drill bits \emptyset 5x110, \emptyset 6x110, \emptyset 8x110, \emptyset 10x110, \emptyset 6x160, \emptyset 8x160, \emptyset 10x160, \emptyset 12x160, \emptyset 8x210, \emptyset 10x210, \emptyset 12x260, \emptyset 14x260 mm 1 of each: Flat chisels 250x40, 140x20, 250x20 Point chisels 140, 250 mm	17	3.364

Installation

R9360 0022

SMALL TUBE CUTTER

- > For copper tubes
- > 2 supporting rollers
- > Metal housing
- > Particularly suitable for barely accessible places
- > Knurled adjusting wheel



Code	No.	Description	\emptyset mm	
3301616	R93600022	Small tube cutter Copper tube-D.3-22mm	3-22	0.140
3301618	R93980005	Spare cutting wheels for copper 5pcs		0.005

R9360 0035

TUBE CUTTER

- > For copper tubes
- > With retractable deburring tool
- > Exact telescope guide
- > Guiding rollers with groove for flared tubes
- > 4 supporting rollers
- > Metal housing
- > Large turning handle



Code	No.	Description	Ø mm	
3301617	R93600035	Tube cutter Copper tube D.3-35mm	3-35	0.560
3301618	R93980005	Spare cutting wheels for copper 5pcs		0.005

R9921 0000

CARTRIDGE CAULKING GUN

- > For processing silicon, packed in bag or cartridge form, for 310 ml contents
- > Stable aluminium tube
- > Easy to handle and clean
- > Quicker and easier cartridge change
- > Supplied with 3 tips



Code	No.	L	H	
3301753	R99210000	340	210	0.840

R9340 0060

SCRAPER

- > For minor improvements/repair
- > Apply, spread and smooth down
- > With wooden handle
- > Hanging hole



Code	No.	Blade width mm	
3301754	R93400060	60	0.100

1000 V

172-177



VDE Screwdriver

R3910XXXX
VDE SCREWDRIVER

for slotted head screws

- > Based on DIN 5264, DIN ISO 2380
- > VDE-insulated acc. to DIN EN 60900
- > Guaranteed protection for working under voltage up to 1000V AC (alternating current) and 1500V DC (direct current)
- > Blade of high-grade chrome-molybdenum steel
- > Driven tip phosphated, corrosion-protected and low-wear
- > Dual-material handle, for easy handling
- > Moulded handle forms a firm unit with the blade
- > 5-edge handle head stops it rolling off when put down
- > Elongated hole in the handle for hanging up



Code	No.	mm	mm	mm	mm	kg
3301400	R39102514	2.5	0.4	75	145	0.030
3301401	R39100319	3.0	0.5	100	170	0.036
3301402	R39100419	4.0	0.8	100	200	0.071
3301403	R39105524	5.5	1.0	125	225	0.091

R3920XXXX
VDE SCREWDRIVER

for cross-head screws PH

- > Based on DIN 7438, DIN ISO 8764
- > VDE-insulated acc. to DIN EN 60900
- > Guaranteed protection for working under voltage up to 1000V AC (alternating current) and 1500V DC (direct current)
- > Blade of high-grade chrome-molybdenum steel
- > Driven tip phosphated, corrosion-protected and low-wear
- > Dual-material handle, for easy handling
- > Moulded handle forms a firm unit with the blade
- > 5-edge handle head stops it rolling off when put down
- > Elongated hole in the handle for hanging up



Code	No.	PH	mm	mm	kg
3301404	R39200115	1	80	180	0.070
3301405	R39200219	2	100	210	0.105

R3930XXXX
VDE SCREWDRIVER

for cross-head screws PZ

- > Based on DIN 7438, DIN ISO 8764
- > VDE-insulated acc. to DIN EN 60900
- > Guaranteed protection for working under voltage up to 1000V AC (alternating current) and 1500V DC (direct current)
- > Blade of high-grade chrome-molybdenum steel
- > Driven tip phosphated, corrosion-protected and low-wear
- > Dual-material handle, for easy handling
- > Moulded handle forms a firm unit with the blade
- > 5-edge handle head stops it rolling off when put down
- > Elongated hole in the handle for hanging up



Code	No.	PZ	mm	mm	kg
3301406	R39300115	1	80	180	0.070
3301407	R39300219	2	100	210	0.104

VDE Pliers

R2930XXXX

VDE COMBINATION PLIERS



- > Based on DIN ISO 5748
- > Complies with VDE 0682 Part 201 and EN/IEC 60900
- > Gripping zones for flat and round stock
- > Induction-hardened long cutting edge
- > 2 dual-material handle for a hands-friendly transfer of force
- > Special tool steel, forged

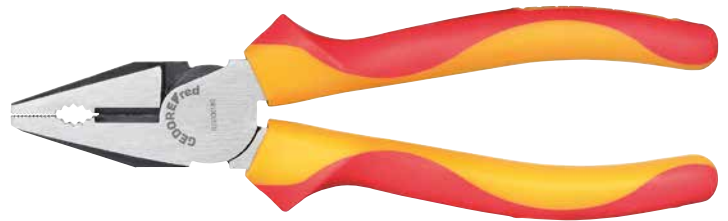

Code	No.	Hard wire Ø mm	l mm	
3301408	R29300180	1,6	180	0.275
3301409	R29300200	1,8	200	0.360

R29400180

VDE POWER SIDE CUTTER



- > Acc. to DIN ISO 5749
- > Complies with VDE 0682 Part 201 and EN/IEC 60900
- > High cutting performance with low force
- > Slim head
- > Induction-hardened long cutting edges
- > 2 dual-material handle for a hands-friendly transfer of force
- > Special tool steel, forged



Code	No.	Piano wire Ø mm	l mm	
3301410	R29400180	1,6	180	0.280

R2950 0200

VDE TELEPHONE PLIERS



straight

- > Based on DIN ISO 5745
- > Complies with VDE 0682 Part 201 and EN/IEC 60900
- > Straight grip surfaces, lengthways-serrated
- > Induction-hardened long cutting edge
- > 2 dual-material handle for a hands-friendly transfer of force
- > Special tool steel, forged



Code	No.	Hard wire Ø mm	l mm	kg
3301411	R29500200	1,8	200	0.260

R2951 0200

VDE TELEPHONE PLIERS



45° angle

- > Based on DIN ISO 5745
- > Complies with VDE 0682 Part 201 and EN/IEC 60900
- > 45° angled grip surfaces, lengthways-serrated
- > Induction-hardened long cutting edge
- > 2 dual-material handle for a hands-friendly transfer of force
- > Special tool steel, forged



Code	No.	Hard wire Ø mm	l mm	kg
3301412	R29510200	1,8	200	0.260

R2910 0010

VDE WATER PUMP PLIERS



7 settings

- > Acc. to DIN ISO 8976 Form C
- > Complies with VDE 0682 Part 201 and EN/IEC 60900
- > Lengthways-serrated grip surfaces
- > With box joint
- > Head and joint polished
- > Chrome-vanadium steel



Code	No.	mm	inch	l mm	kg
3301413	R29100010	39	10	250	0.393

VDE sets

R3900 2005

VDE SET

5 pieces

**VDE Screwdriver:**

- > for slotted head screws: Acc. to DIN 5264, DIN ISO 2380
- > for cross-head screws PH: Acc. to DIN 7438, DIN ISO 8764
- > VDE-insulated acc. to DIN EN 60900
- > Guaranteed protection for working under voltage up to 1000V AC (alternating current) and 1500V DC (direct current)
- > Blade of high-grade chrome-molybdenum steel
- > Driven tip phosphated, corrosion-protected and low-wear
- > Dual-material handle, for easy handling
- > Moulded handle forms a firm unit with the blade
- > 5-edge handle head stops it rolling off when put down
- > Elongated hole in the handle for hanging up

VDE Side cutter:

- > Acc. to DIN ISO 5749
- > Complies with VDE 0682 Part 201 and EN/IEC 60900
- > Slim head
- > Induction-hardened long cutting edges
- > 2 dual-material handle for a hands-friendly transfer of force
- > Special tool steel, forged

VDE Telephone pliers, straight pattern:

- > Acc. to DIN ISO 5745
- > Complies with VDE 0682 Part 201 and EN/IEC 60900
- > Straight grip surfaces, lengthways-serrated
- > Induction-hardened long cutting edges
- > 2 dual-material handle for a hands-friendly transfer of force
- > Special tool steel, forged



Code	No.	Contents	pieces	
3301414	R39002005	Slotted 3, 5.5 mm Cross-slotted PH 2 VDE Side cutter 180 mm VDE Telephone pliers 200 mm, straight pattern	5	0.833

VDE Knives

R9322 0028

VDE CABLE KNIFE



- > VDE-insulated acc. to DIN EN 60900
- > Stable, straight blade
- > Straight cutting edge
- > Protective cap
- > Dual-material handle, for easy handling



Code	No.		
3301415	R93220028	185	0.143

R9322 0128

VDE CABLE KNIFE



- > Stable, partially-insulated and replaceable blade
- > Straight cutting edge
- > Supplied with a replacement blade
- > Integrated protective cap
- > Safety handle of impact-resistant plastic



Spare blade R93970004

Code	No.	Description	↳ mm ↳	kg
3301416	R93220128	VDE-Cable knife blades-L.45mm L.185mm	185	0.095
3301417	R93970004	Cable knife blade f.R93220128 4pcs		0.100

Voltage tester

R3812 0000

VOLTAGE TESTER

- > Acc. to DIN ISO 0680
- > 8 LED displays
- > DC and AC testing
- > Display 6 / 12 / 24 / 50 / 120 / 230 / 400 V AC/DC
- > Frequency range 0 - 500 Hz
- > Degree of protection IP65



Code	No.	kg
3301418	R38120000	0.120

Lamps

R9530 0017

LED TORCH

- > Aluminium housing
- > Delivery **without** three AAA batteries
- > Hanger
- > 2 levels of brightness plus warning/signal function
- > 1 W LED
- > Luminous flux 55-60 lm
- > Light range 25-30 m
- > Technical specifications subject to modifications



Code	No.	↳ mm ↳	kg
3301755	R95300017	130	0.156

AUTOMOTIVE

178 - 189



Steering and steering geometry tools

R11203003

DISMANTLING AND ASSEMBLY FORK SET

5 pieces

- > For rapidly detaching track and push rod ends, steering arms and other control parts
- > Replaceable fork ends
- > Handle grip for manual hammer socket
- > Chisel adapter for compressed air chisel hammer socket
- > Special steel
- > Plastic case
- > **Note: The dismantling and assembly fork damages the rubber sleeve**



Code	No.	Contents	L	W	D	pieces	kg
3301555	R11203003	Fork end opening 17.5 mm Fork end opening 23.5 mm Fork end opening 28.5 mm Handle grip l = 200 mm Adapter l = 175 mm Ø 10 mm	295	190	50	5	2.0

R11201002

UNIVERSAL BALL JOINT PULLER

- > For ejecting the ball joint journal from the steering arm, steering knuckles, anti-roll bars etc.
- > Spindle hex, width-across-flats 21 mm
- > 2-level clamping height
- > Special forged steel



Code	No.	Fork head opening	Clamping height	mm	kg
3301558	R11201002	20	50	160	1.454

Tools for motors

R15151000

SET OF HOSE CLAMP PLIERS

3 pieces

- > For disconnecting flexible hose lines, Ø up to approx. 60 mm
- > Adjustable lock with stopping function
- > Temperature-resistant up to 160°
- > Made of special-purpose plastic



Code	No.	Plier lengths	For diameter	pieces	kg
3301539	R15151000	160 mm 185 mm 255 mm	Ø up to approx. 60 mm	3	0.298



R15551000

OIL FILTER SPANNER

12.5mm
1/2"

- > For safe, rapid unscrewing of oil filters
- > Continuously adjustable, hand-operated
- > Drive 1/2" acc. to DIN 3120 - C 12.5, ISO 1174 and AF 19 mm
- > Holding segments stop any slipping
- > For use in tight spots



Code	No.	Model		
3301540	R15551000	65 - 120 mm Ø		0.315

R15551001

OIL FILTER STRAP WRENCH

12.5mm
1/2"

- > For safe, rapid unscrewing of oil filters
- > Continuous adjustment of the filter belt
- > Drive 1/2" (12.5 mm)
- > Hand-operated



Code	No.	for diameter	↳ mm ↳	
3301541	R15551001	up to 152 mm	150	0.240

R15553004

OIL SERVICE WRENCH SET 3/8"

10mm
3/8"

12 pieces

- > Ideal combination for fitting/removing oil draining and gear oil control screws
- > Suitable sockets for various drive types
- > Drive 3/8" acc. to DIN 3120 - C 10, ISO 1174, AF 19 or tommy bar 8 mm Ø
- > Hand-operated
- > Chrome-vanadium steel
- > In a robust plastic case



Code	No.	Contents	L	W	D	pieces	
3301544	R15553004	Socket 3/8" in-hex 8 9 3/8" (9.5 mm) 10 12 14 17 Socket 3/8" in-square 8 + 5/16" 3/8" (9.5 mm) 11 13 3/8" sliding T-handle	235	190	55	12	1.1

R15151001

FUEL TANK SENSOR SPANNER SET ADJUSTABLE

2 pieces

- > For loosening and tightening the plastic lock ring of the fuel sensor on fuel tanks
- > Fast gear wheel function for diameter adjustment
- > Hexagon drive, AF 24 mm
- > Hand-operated
- > Chrome-vanadium steel



Code	No.	Contents	pieces	kg
3301585	R15151001	Fuel tank sensor spanner Ø 80 - 120 mm Fuel tank sensor spanner Ø 110 - 170 mm	2	0.800

R15203000

CYLINDER HEAD DRILL GAUGE SET

30 pieces

- > Considerable time saving – 2 - 4 hours – No need for cylinder head removal.
- > This adjustable universal drilling gauge set allows severed and ripped out studs - particularly at cylinder heads and exhaust flanges - to be rapidly and precisely bored without removing the cylinder head (M8 and M10 bolt threads)

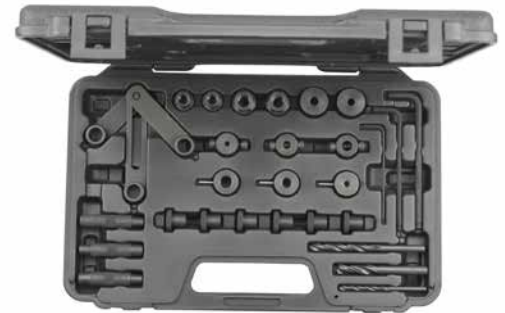

Code	No.	Contents	pieces	kg
3301590	R15203000	1x drill template 3 pcs 3x centring pins conical 3x guide sleeves Ø 8 + Ø 10 2x SK collar nuts M8 + M10 1x drill sleeve with cylinder pin 4.0 6.5 8.5 mm 1x guide sleeve M8 M10 1x drill stop with cylinder head screws 4.0 6.5 8.5 mm 1x hexagon key 2 4 5 mm 1x twist drill Ø 4.0 6.5 8.5 mm	30	1.400

Tools for gear repairing

R17151000

PULLER

with clamping yoke

- > Spindle with hexagon drive, AF 17 mm
- > Bow screw with hexagon drive, AF 17 mm



Code	No.	Clamping reach max.	Clamping depth	max. t	kg
3301554	R17151000	90	100	1.0	1.7



Tools for bodywork and interior trim

R18101000 SPRAY NOZZLE NEEDLE

for adjusting and cleaning

- > Practical service tool
- > Stable, scribe-like adjusting tip with thin cleaning rod
- > Ideal for cleaning and adjusting windscreen spray nozzles and headlight spray nozzles
- > Holding clip and protective cap
- > Aluminium



Code	No.	↳ mm	
3301549	R18101000	95	0.024

R18201000 LABEL SCRAPER

- > For quick, reliable removal of stickers, sealing strips and adhesive residues
- > Stable blade holder
- > Blades replaceable
- > Safety cap
- > Single-component handle with hole for hanging up



Code	No.	Blade width	↳ mm	
3301566	R18201000	40	165	0.100

General tools

R9911XXXX WORK GLOVES

- > Optimum fit
- > Gripping surfaces for small and smooth parts
- > One-piece palms
- > Breathable space between the fingers
- > Adjustable wrist cuff stops the glove from slipping
- > Adhesion to smooth surfaces ensured from internal coating
- > Protection of damageable surfaces



Ill. similar

Code	No.	Size	
3301749	R99110005	M	0.080
3301750	R99110010	L	0.095
3301751	R99110015	XL	0.090
3301752	R99110020	XXL	0.090

R1935XXXX

STRAP WRENCH

- > Strong, non-slip fabric strap
- > Dip-insulated
- > Chrome-vanadium steel 31CrV3, chrome-plated



Code	No.	Contents	↳ mm ↲	∅ mm	⚖ kg
3301465	R19351019	Strap wrench	570	140	0.278
3301466	R19991019	Spare strap for strap wrench	490		0.080

R19351031

STRAP WRENCH

- > Strong, non-slip fabric strap
- > Plastic-covered handle
- > Chrome-vanadium steel 31CrV3, chrome-plated



III. similar

Code	No.	↳ mm ↲	∅ mm	⚖ kg
3301467	R19351031	810	200	0.364

R19101000

TELESCOPIC MAGNETIC LIFTER WITH SCRIBER

- > With clip and protective cap
- > Aluminium
- > With magnet



Code	No.	↳ mm ↲	magnet ∅	∅	⚖ kg
3301546	R19101000	150-670	7.5	300	0.046



R19101001

HOOK ASSORTMENT

4 pieces

- > Fitting/removing O-rings, and engine, gear, steering and hydraulic gaskets
- > For work on bodywork interior trim
- > 1-component handle



Code	No.	pieces	↳ mm	
3301548	R19101001	4	135	0.200

R19102000

MAGNETIC TRAY

- > Secure storage of small metal parts
- > Stainless steel
- > 2 extra strong rubber-protected magnets



Code	No.	L	W	
3301547	R19102000	240	140	0.744

R19201000

TIRE THREAD DEPTH GAUGE OF BRASS

- > Non-dazzle read-off
- > Tip for depth gauge (tire treads)
- > Robust hard brass type



Code	No.	↳ mm	
3301552	R19201000	100	0.060

R19153000

EXTRACTOR SET 3/8"



14 pieces

- > For slackening and removing bolts and damaged screws
- > Anticlockwise cutting thread with 6 cutting edges tapering together
- > Square drive acc. to DIN 3120 - C 10, ISO 1174, with ball retention groove
- > Hexagon head at the sockets as alternative drive
- > **Hand-operated**
- > Special compact design
- > Special steel
- > In a robust plastic case



Code	No.	Contents	L	W	D	pieces	kg
3301563	R19153000	Removing socket 3/8": 6.3 mm (1/4"), 8 mm (5/16") 9.5 mm (3/8"), 10 mm 11 mm (7/16"), 12 mm 12.5 mm (1/2"), 13 mm 14 mm (9/16"), 16 mm (5/8") 17 mm, 17.5 mm (11/16") 19 mm (3/4") Punch	190	110	40	14	0.730

R68003010

EXTRACTOR SET 1/2"



10 pieces

- > Square drive acc. to DIN 3120 - C 12.5, ISO 1174, with ball retention groove
- > For slackening and removing bolts and damaged screws
- > Anticlockwise cutting thread with 6 cutting edges tapering together
- > Hexagon head at the sockets as alternative drive
- > **Hand-operated**
- > Special compact design
- > Special steel
- > In a robust plastic case



Code	No.	Contents	L	W	D	pieces	kg
3300034	R68003010	1/2" 10 11 12 13 14 15 16 17 19 mm Punch	130	130	55	10	0.950



R90610075

PRY BAR

offset

- > Heavy-duty type
- > Chrome-vanadium steel



Code	No.	↳ mm ↳	📏
3301464	R90610075	610	1.340

R19101003

PRY BAR

- > Particularly for body and interior equipment
- > Chrome-plated blade
- > Special form
- > 1-component handle



Code	No.	↳ mm ↳	Blade width	📏
3301569	R19101003	275	26	0.175

R19101002

PRY BAR SET

4 pieces

These special steel pry bars are ideal for:

- > Pushing off jammed components
- > Positioning components
- > Holding components in position
- > Flaring press-fit bores, etc.
- > 1-component handle



Code	No.	Contents	pieces	📏
3301568	R19101002	24", 610 x 20 mm 18", 460 x 20 mm 12", 310 x 16 mm 8", 200 x 10 mm	4	1.4

Sets

R68003013

CROW'S FOOT SOCKET SET

12,5mm
1/2"

13 pieces

- > Square plug-in handle with swivel square drive acc. to DIN 3120 - C 12.5, ISO 1174, with ball retention groove
- > Open screw profiles for repairs on cables, for instance
- > Chrome-molybdenum steel



Code	No.	Contents	L	W	D	pieces	kg
3301589	R68003013	20 21 22 23 24 25 26 27 28 30 32 mm Square plug-in handle Extension 125 mm	480	195	55	13	3.000

R68003075

ASSEMBLY TOOL SET TX 1/4" + 1/2"



75 pieces

- > Coupler in acc. with DIN 3120, ISO 1174, with ball locking device
- > Square drive acc. to DIN 3120, ISO 1174, with ball retention groove
- > Socket 1/4" + 1/2", recessed TX
- > Screwdriver bit socket 1/4", TX, with pressed-in, phosphated pin
- > Bit adapter 1/4", with in-square and in-hex, for all bits and tools with a 1/4" outer hex
- > Bit adapter 1/2", with in-square and in-hex, for all bits and tools with a 10mm (3/8") outer hex
- > Bit 1/4" TX B0, for holders in acc. with DIN ISO 1173 - D 6.3
- > Bit 10mm (3/8") TX, for holders in acc. with DIN ISO 1173 - D 10
- > Hexagon socket key set TX
- > Double-ended ring spanners TX
- > 1K screwdriver TX
- > Telescopic holder with magnet
- > Chrome-vanadium steel, matt satin chrome-plated
- > For hand-operated bolting operations
- > Plastic case in the GEDORE red Design
- > Clamp-secured tools
- > Metal hinges/lock



Code	No.	Contents	L	W	D	pieces	kg
3301575	R68003075	1/4" socket TX E4 E5 E6 E7 E8 E10 E11 25 mm 1/4" screwdriver bit socket TX T7 T8 T9 T10 T15 T20 T25 T27 T30 T40 37 mm 1/4" bit adapter square x hex 25 mm 1/4" bits TX with hole T7 T8 T9 T10 T15 T20 T25 T27 T30 T40 25 mm 1/2" socket TX E12 E14 E16 E18 E20 E22 E24 Bit adapter 1/2" 4kt x 10 mm 6kt 38 mm 10mm bits TX T40 T45 T50 T55 T60 30 mm 10mm bits TX T15 T20 T25 T30 T40 T45 T50 T55 T60 75 mm Screwdriver TX T8x60 T10x80 T15x80 T20x100 T25x100 T27x125 T30x125 T40x150 mm Double-ended ring spanner TX E6xE8 E10xE12 E14xE18 E20xE24 Hexagon socket key TX T8 T10 T15 T20 T25 T27 T30 T40 T45 T50 T55 T60 Telescopic magnetic lifter with scriber 126 - 636 mm	383	272	80	75	3.5



R58003002

SCREWDRIVER BIT SOCKET SET

3/8" TX



10 pieces

- > Screwdriver bit socket 3/8", for recessed TX screws, square drive in acc. with DIN 3120 - C 10, ISO 1174, with ball retention groove
- > Long blades
- > Matt chrome-plated
- > Chrome-vanadium steel
- > Clamp-secured tools
- > Sturdy plastic case



Code	No.	Contents	L	W	D	pieces	
3301576	R58003002	Screwdriver bit socket TX T10 T15 T20 T25 T27 T30 T40 T45 T50 T55 200 mm	295	195	54	10	0.800

R68003026

SCREWDRIVER BIT SOCKET SET

1/2" XZN



26 pieces

- > Square drive acc. to DIN 3120 - C 12.5, ISO 1174, with ball retention groove
- > Screwdriver bit socket 1/2", XZN, with pressed-in, phosphated pin, non-slip knurled head, brightly polished on the drive side
- > Chrome-vanadium steel, matt satin chrome-plated
- > For hand-operated bolting operations
- > Plastic case in the GEDORE red Design
- > Clamp-secured tools
- > Metal hinges/lock



Code	No.	Contents	L	W	D	pieces	
3301574	R68003026	Screwdriver bit socket XZN M5 M6 M8 M9 M10 M12 M14 M16 55 mm Screwdriver bit socket XZN M5 M6 M8 M9 M10 M12 M14 100 mm Screwdriver bit socket XZN M5 M6 M8 M9 M10 M12 M14 140 mm Screwdriver bit socket XZN M8 M10 M12 M14 200 mm	425	320	52	26	5.4

R68003032

SCREWDRIVER BIT SOCKET SET

1/2" TX



32 pieces

- > Square drive acc. to DIN 3120 - C 12.5, ISO 1174, with ball retention groove
- > Screwdriver bit socket 1/2", TX, with pressed-in, phosphated pin, non-slip knurled head, brightly polished on the drive side
- > Chrome-vanadium steel, matt satin chrome-plated
- > For hand-operated bolting operations
- > Plastic case in the GEDORE red Design
- > Clamp-secured tools
- > Metal hinges/lock



Code	No.	Contents	L	W	D	pieces	
3301577	R68003032	Screwdriver bit socket TX T20 T25 T27 T30 T40 T45 T50 T55 T60 T70 55 mm	425	320	52	32	5.4
		Screwdriver bit socket TX T20 T25 T27 T30 T40 T45 T50 T55 T60 T70 100 mm					
		Screwdriver bit socket TX T40 T45 T50 T55 T60 T70 140 mm					
		Screwdriver bit socket TX T40 T45 T50 T55 T60 T70 200 mm					

R68003030

SCREWDRIVER BIT SOCKET SET

1/2" IN



30 pieces

- > Square drive acc. to DIN 3120 - C 12.5, ISO 1174, with ball retention groove
- > Screwdriver bit socket 1/2", hex, metric, with pressed-in, phosphated pin, non-slip knurled head, brightly polished on the drive side, design based on DIN 7422
- > Chrome-vanadium steel, matt satin chrome-plated
- > For hand-operated bolting operations
- > Plastic case in the GEDORE red Design
- > Clamp-secured tools
- > Metal hinges/lock



Code	No.	Contents	L	W	D	pieces	
3301573	R68003030	Screwdriver bit socket in-hex, 5 6 7 8 10 12 14 17 19 55 mm	425	320	52	30	5.4
		Screwdriver bit socket, in-hex 5 6 7 8 10 11 12 13 100 mm					
		Screwdriver bit socket in-hex 5 6 7 8 10 12 14 140 mm					
		Screwdriver bit socket in-hex, 5 6 7 8 10 12 200 mm					



A

Adapter and extension set 6in2..... 086
 Adjustable spanners 064, 065
 Assembly tool set TX 1/4" + 1/2" 109, 187

B

Bent nose telephone pliers..... 139, 140
 Bit adapter 1/2" 086
 Bit box 1/4" 135, 136
 Bit holder 074
 Bit ratchet 1/4" 068
 Bit ratchet set 1/4" with adaptor compact 095
 Bit screwdriver 1/4" 073, 132
 Bit set 10 mm SK / XZN / TX 137
 Bolt Cutters 141
 Bricklayer's chisel..... 153, 154

C

Carbide scribe with clip..... 161
 Carpenter's hammer 152
 Cartridge caulking gun 171
 Centre punch..... 156
 Circlip pliers for external retaining rings 141, 142
 Circlip pliers for internal retaining rings..... 142
 Circlip pliers set 143
 Claw hammer, American pattern 152
 Club hammer..... 150
 Combination pliers..... 139
 Combination ratchet spanner..... 053, 054
 Combination ratchet spanner set..... 053, 054, 055
 Combination spanner set..... 063, 064
 Combination spanner set and hexagon socket key set ... 045
 Combination spanners 062, 063
 Coupler 125
 Cranked socket key 133
 Cranked socket key set 134
 Cross-cut chisel..... 154
 Crow's foot socket set 187
 Curved jaw locking pliers set..... 145
 Cylinder head drill gauge set..... 181

D

(De)magnetiser..... 135
 Digital measuring calliper 160
 Dismantling and assembly fork set 179
 Double box ratchet wrench 058
 Double box ratchet wrench set..... 057, 058
 Double box ratchet wrenches..... 057
 Double open-ended spanner in wallet..... 060
 Double open-ended spanner set 045, 061, 062
 Double open-ended spanners..... 060, 061
 Double ring spanner..... 059
 Double ring spanner set..... 059
 Double-ended ring spanner set 044
 Drift punch 156
 Drift punch set 157
 Drive adapter 1/4" 073, 074

E

2C-Electronics screwdriver set 130
 Electricians' chisel..... 155
 Engineers' hammer 149
 Extendable shank screwdriver 13in1..... 132
 Extractor set 1/2" 105, 185
 Extractor set 3/8" 098, 185

F

Feeler gauge set..... 161
 File set..... 167
 Files 167
 Flat chisel 153
 Flexible head combination ratchet spanner 056
 Flexible head combination ratchet spanner set 057
 Fuel tank sensor spanner set adjustable 181

H

Hacksaw 166
 Half-moon ring spanner 060
 Hammer and chisel set 051
 Heavy-duty utility knife 163
 Holding rail for sockets 115

Hook assortment.....	184	Oil service wrench set 3/8".....	180
		Open ratchet spanner with flare ring end set.....	056
I			
Ideal pattern snips.....	165	P	
Impact extension 1".....	123	Pencil.....	161
Impact extension 1/2".....	118	Phase tester 105-250V.....	130
Impact extension 3/4".....	121	Phase tester 220-250V.....	131
Impact socket 1".....	122	Phase tester max. 250V.....	131
Impact socket 1/2".....	117, 118	Pin punch.....	155
Impact socket extension piece 1/2" to 3/4".....	119	Pin punch set.....	157
Impact socket extension piece 3/4" to 1".....	121	Pincer.....	140
Impact socket reducer 1/2" to 3/8".....	119	Pipe wrench.....	143, 144
Impact socket reducer 3/4" to 1/2".....	121	Pliers set.....	051, 140
Impact socket set 1/2".....	049, 116	Pliers, hammer, chisel set.....	040
Impact tool socket set 1/2".....	115, 116	Pocket knife.....	164
Impact universal joint 1/2".....	118	Point chisel.....	155
		Power side cutter.....	139
K			
Key file set.....	167	Protecting chisel set.....	156
		Protective hand guard.....	153
L			
Label scraper.....	182	Pry bar.....	186
LED torch.....	177	Pry bar set.....	186
Locking pliers.....	145	Puller.....	181
Long nose locking pliers.....	145		
		Q	
M			
Machinists' hammer.....	151	Quick-change bit holder 1/4".....	074
Magnetic tray.....	184		
Measuring and cutting tools set.....	042	R	
Multifunction saw.....	166	2C ratchet handle with coupler 1/2".....	079
Multifunction tool.....	165	2C reversible ratchet 1/2".....	078
		2C reversible ratchet 1/4".....	067
N			
Nylon hammer.....	151	2C reversible ratchet 3/8".....	075
		Ratchet screwdriver 1/4" with telescopic blade.....	131
O			
Oil filter spanner.....	180	Ratchet with accessories 1/2".....	048
Oil filter strap wrench.....	180	Ratchet wrench and double open-ended spanner set... ..	044
		Ratchet wrench and hexagon socket key set.....	046
		Ratchet wrench set.....	046, 047
		Reducer 1" x 3/4".....	089
		Reducer 1/2" x 3/8".....	086
		Reducer 3/4" x 1/2".....	089

R

Reducer 3/8" to 1/4"	077	Sledge hammer	150
Retaining ring pliers set	050	Sliding T-bar with slider 1/2"	085
Reversible ratchet 3/4"	087	Sliding T-bar with slider 1/4"	071
Rubber hammer	150, 151	Sliding T-bar with slider 3/4"	088
		Sliding T-bar with slider 3/8"	076

S

2C-Screwdriver	127, 128	Socket	074
2C-Socket wrench	135	Socket 1/2"	080, 081, 082
2C swivel head bit ratchet 1/4"	068	Socket 1/4"	069, 070
2C swivel head reversible ratchet 1/2"	078	Socket 3/4"	087
2C swivel head reversible ratchet 1/4"	068	Socket 3/8"	076
2C swivel head reversible ratchet 3/8"	075	Socket extension 1/2"	085
2C swivel-head telescopic ratchet	079	Socket extension 1/4"	072
Safety ring / 9in 1/2"	119	Socket extension 3/4"	088
Safety ring / 9in 3/4"	121	Socket extension 3/8"	077
Safety ring / pin 1"	123	Socket extension piece 1/2" x 3/4"	086
Scraper	171	Socket extension piece 3/4" - 1"	089
Screw remover set	137	Socket extension piece 3/8" to 1/2"	077
Screwdriver and file set	041	Socket holder 1/4"	073
Screwdriver bit socket 1/2"	083, 084	Socket set 1/2"	048, 099, 100, 106, 114
Screwdriver bit socket 1/4"	070, 071	Socket set 1/2" TX	105
Screwdriver bit socket set 1/2"	048	Socket set 1/4"	047, 091, 092, 093, 094
Screwdriver bit socket set 1/2" IN	107, 189	Socket set 1/4" + 1/2"	099, 101, 102, 103
Screwdriver bit socket set 1/2" TX	107, 189	Socket set 1/4" + 1/2" and accessories	039
Screwdriver bit socket set 1/2" XZN	108, 188	Socket set 1/4" + 3/8" + 1/2"	104
Screwdriver bit socket set 3/8" TX	098, 188	Socket set 3/4"	110
Screwdriver bit sockets 1/2"	112	Socket set 3/8"	096, 097
Screwdriver bit sockets 1/2"	113	Socket set 3/8" + 1/2"	106
Screwdriver bit sockets 1/4"	111	Sockets 1/2"	112
Screwdriver set	049, 128, 129	Sockets 1/4"	110
Screwdriver set TX	050, 130	Sockets 3/8" and 1/2"	111
Screwdriver set XXL	129	Sockets/sockets 1/2"	114
Screwdriver, pliers, hammer and chisel set	043	Spark plug socket 1/2"	082
SDS Masonry drill bit set	170	Special set ELECTRO-TECHNICS	019
Set impact sockets 3/4"	120	Spirit level	159
Set of hose clamp pliers	179	Splitting chisel	154
Set of lengthwise dividers for the MECHANIC workshop trolley	033	Spray nozzle needle	182
Side cutter	139	Square drive adapter set	056, 072
		Square plug-in handle 1/4"	071

Square plug-in handle 1/4"	132	VDE Combination Pliers	174
Strap wrench	183	VDE Power side cutter	174
Striking tool set	157	VDE screwdriver	173
Stripping pliers	140	VDE Screwdriver set	050
		VDE set	176
		VDE Telephone pliers	175
		VDE water pump pliers	175
		Vice	147
		Voltage tester	177
T		W	
2C telescopic ratchet	079	Water pump pliers	144
2C-T-handle cranked socket key set	133	Wheel wrench	065
2C-T-handle cranked wrench key	133	Wire brush	168
Tape measure	160	Wood sectioned folding ruler	160
Telescopic magnetic lifter with scriber	183	Work gloves	182
Tire thread depth gauge Brass design	184	Workshop trolley MECHANIC PLUS with 6 drawers	030
Tool box	025	Workshop trolley MECHANIC with 6 drawers	029
Tool case	026	Workshop trolley MECHANIC with tool set	031, 032, 033
Tool chest WINGMAN	037	Workshop trolley WINGMAN with 4 drawers	034
Tool set	020, 021, 022, 023	Workshop trolley WINGMAN with tool set	035, 037
Tool set T bar with ratchet 1/4"	095		
Tool wallet	026		
Tool/laptop bag	027		
Torque wrenches	125		
Tower pincer	141		
Tube cutter	171		
Twist drill bit set, blank	169		
Twist drill bit set, rolled	169, 170		
U			
Universal ball joint puller	179		
Universal joint 1/2"	085		
Universal joint 1/4"	072		
Universal joint 3/4"	088		
Universal scissors	165		
Universal set ALL-IN	018		
Universal set ALLROUND	016		
Universal set BASIC	015		
Universal set MECHANIC	017		
Utility knife	163, 164		
V			
VDE Cable knife	176, 177		

R0110xxxx	.059	R19101002	.186
R0135xxxx	.060	R19101003	.186
R01700057	.065	R19102000	.184
R0310xxxx	.064	R19153000	.098
R0380xxxx	.064	R19153000	.185
R0391xxxx	.065	R19201000	.184
R0510xxxx	.061, 062	R19351031	.183
R05126008	.060	R1935xxxx	.183
R0512xxxx	.060, 061	R2015xxxx	.029
R05905010	.056	R2020xxxx	.034, 036
R0710xxxx	.053	R20240003	.037
R07203012	.055	R20400006	.030
R07203016	.055	R20600073	.025
R0720xxxx	.054	R20650066	.026
R07305005	.057	R20702069	.027
R0730xxxx	.056	R20750063	.025
R07405006	.057	R20802012	.026
R0740xxxx	.057	R2085xxxx	.115
R07501002	.058	R20901500	.033
R07501019	.058	R21000042	.019
R0910xxxx	.062, 063	R21000057	.017
R09115016	.064	R21000059	.016
R0911xxxx	.063	R21000072	.015
R11201002	.179	R21000108	.018
R11203003	.179	R21010000	.020
R15151000	.179	R21010001	.021
R15151001	.181	R21010002	.022
R15203000	.181	R21010004	.023
R15551000	.180	R21560001	.031
R15551001	.180	R21560002	.032
R15553004	.180	R21560004	.033
R17151000	.181	R22041004	.035
R18101000	.182	R22071004	.037
R18201000	.182	R22150000	.044
R19101000	.183	R22150001	.045
R19101001	.184	R22150002	.046

R22150003	047	R2830xxxx	139
R22150006	047	R28402160	139
R22150008	048	R2842xxxx	139
R22150009	048	R2850xxxx	139
R22150011	048	R2851xxxx	140
R22150012	049	R2880xxxx	141
R22150013	049	R28904201	140
R22150014	049	R2892xxxx	141
R22150015	050	R29100010	175
R22150016	050	R2930xxxx	174
R22150017	050	R29400180	174
R22150018	051	R29500200	175
R22150019	051	R29510200	175
R22250000	045	R33005007	135
R22250001	046	R33005009	136
R22350000	039	R33005014	136
R22350001	040	R33005031	136
R22350002	041	R35003040	137
R22350004	042	R36405009	134
R22350005	043	R36605009	134
R22350006	044	R3660xxxx	133
R2710xxxx	143	R36675009	134
R2714xxxx	143	R38002006	128
R2716xxxx	144	R38002012	129
R27202003	145	R38002106	129
R2720xxxx	145	R38004006	137
R27220065	145	R38005906	130
R2760xxxx	141	R3810xxxx	127
R2765xxxx	142	R38120000	177
R2770xxxx	142	R38120312	130
R2775xxxx	142	R38120419	131
R28002003	140	R38121312	131
R28002004	143	R3820xxxx	127
R2810xxxx	144	R3830xxxx	127
R28154010	144	R38402006	130
R28202176	140	R3840xxxx	128

R3850xxxx	135	R4710xxxx	073
R38672006	133	R47110009	073
R3867xxxx	133	R4711xxxx	074
R38910000	131	R47120011	074
R38920000	132	R48008013	111
R38950000	073	R49003016	093
R38950000	132	R49003033	093
R38950001	071	R49003046	094
R38950001	132	R49004033	091
R38990000	135	R49005023	095
R39002005	176	R49005037	095
R3910xxxx	173	R49014033	092
R3920xxxx	173	R49044033	092
R3930xxxx	173	R50000027	075
R40000027	067	R50050009	075
R40050009	067	R50120027	075
R40120027	068	R5100xxxx	076
R40150027	068	R5510xxxx	077
R40170027	068	R55200039	076
R41008012	110	R57300005	077
R4100xxxx	069	R57500004	077
R4120xxxx	070	R58003002	098
R4245xxxx	070	R58003002	188
R4246xxxx	071	R58018012	111
R4255xxxx	070	R59003026	096
R4510xxxx	072	R59003059	097
R45200022	071	R60000027	078
R45300005	072	R60010027	079
R45603172	104	R60050009	078
R46003092	101	R60110009	079
R46003094	102	R60120027	078
R46003100	103	R60600006	079
R46004049	099	R61003114	106
R47001004	056	R6100xxxx	080
R47001004	072	R61021612	082
R47100003	074	R61022112	082

R6110xxxx	081	R68003075	109
R61208007	112	R68003075	187
R6120xxxx	082	R68008009	114
R62458107	113	R68003010	185
R6245xxxx	084	R69003024	100
R62558010	112	R69004024	099
R62558110	113	R69008012	114
R6255xxxx	083	R69013024	100
R6270xxxx	084	R70000003	087
R63003008	115	R7100xxxx	087
R63003012	116	R7300xxxx	120
R6300xxxx	117	R73981005	121
R63043003	116	R7510xxxx	088
R6304xxxx	118	R7510xxxx	121
R6398xxxx	119	R75200091	088
R6510xxxx	085	R75300021	088
R65200049	085	R77300011	089
R65300012	085	R77400011	121
R6610xxxx	118	R77500009	089
R66300014	118	R77600010	121
R67100006	086	R78004014	110
R67131002	086	R8300xxxx	122
R67300009	086	R83981105	123
R67400008	119	R86100059	123
R67500007	086	R87500012	089
R67600005	119	R90000006	157
R68003010	105	R90100006	157
R68003013	187	R9010xxxx	156
R68003016	105	R9015xxxx	156
R68003020	106	R9020xxxx	155, 157
R68003026	108	R90610075	186
R68003026	188	R90900020	161
R68003030	107	R90950012	161
R68003030	189	R9114xxxx	153
R68003032	107	R9125xxxx	153
R68003032	189	R9129xxxx	154

R91310041	155	R93710043	168
R91370039	154	R93710143	168
R9140xxxx	155	R93800125	147
R91490016	154	R93800150	147
R91901004	156	R93xxxxxx	163
R91990000	153	R9410xxxx	159
R9210xxxx	149	R94420021	160
R9212xxxx	149	R94500002	160
R9216xxxx	151	R9455xxxx	160
R9220xxxx	150	R94650013	161
R92300083	150	R95300017	177
R92402024	152	R9911xxxx	182
R92420023	152	R99210000	171
R92430023	152	R99800000	165
R9250xxxx	150, 151	Rx890xxxx	125
R92600030	151	Rx899xxxx	125
R93000005	167		
R93000006	167		
R931xxxxx	167		
R9320xxxx	164		
R9321xxxx	163		
R93220028	176		
R93220128	177		
R93250008	164		
R93300031	165		
R9331xxxx	165		
R93350051	166		
R9335xxxx	166		
R93400060	171		
R93500025	169		
R93500170	170		
R93510025	169		
R93550017	170		
R93600022	170		
R93600035	171		
R93700043	168		

CONTACTS

GEDORE-Werkzeugfabrik GmbH & Co. KG

Remscheider Straße 149
42899 Remscheid · Germany
Tel. + 49 (0) 21 91- 596 - 0
Fax + 49 (0) 21 91- 596 - 230
info@gedore.com
www.gedore.com

Vertrieb DEUTSCHLAND

Tel. + 49 (0) 21 91- 596 - 900
Fax + 49 (0) 21 91- 596 - 999

Sales INTERNATIONAL

Tel. +49(0)2191-596-910
Fax +49(0)2191-596-911

GEDORE Austria GmbH

Gedore-Str. 1
8190 Birkfeld / Stmk.
AUSTRIA

Tel. +43 (0) 3174 / 363 60
Fax +43 (0) 3174 / 363 83 20

verkauf@gedore.at
www.gedore.at

GEDORE IBÉRICA S.L.

c/Arangutxi 12
Poligono Industrial de Júndiz
01015 Vitoria Alava
SPAIN

Tel. +34-945-29 22 62
Fax +34-945-29 21 99

gedore@gedore.es
www.gedore.es

GEDORE France SARL

Parc d'activités des Béthunes - La Mare II
10, avenue du Fief - Bât. 12
BP 79144 Saint-Ouen-l'Aumône
F-95074 Cergy Pontoise Cedex
FRANCE

Tél. +33 (0)1 34 40 16 60
Fax +33 (0)1 34 40 16 61

info@gedore.fr
www.gedore.fr

GEDORE OMNITOOL GmbH

Fluestr. 25
8957 Spreitenbach
SWITZERLAND

Tel. +41 (0) 56 / 418 40 50
Fax +41 (0) 56 / 418 40 55

gedore-omnitool@gedore.com
www.gedore.ch

GEDORE UK Limited

Marion Street
SKIPTON BD23 1TF
North Yorkshire
UNITED KINGDOM

Tel. +44 (0) 1756 / 70 67 00
Fax +44 (0) 1756 / 79 80 83

sales@gedoreuk.com
www.gedoreuk.com

GEDORE TECHNAG B.V.

Flemingweg 7
2408 AV Alphen aan den Rijn
NETHERLANDS

Tel. +31 (0) 172 / 42 73 50
Fax +31 (0) 172 / 42 73 60

technag@gedore.nl
www.gedore.nl

GEDORE POLSKA Sp. z o.o.

ul. Żwirki i Wigury 56a
43-190 Mikołów
POLAND

Tel. +48 (0) 32 / 738-40 10
Fax +48 (0) 32 / 738-40 20

gedore@gedore.pl
www.gedore.pl

GEDORE TOOLS, INC.

7187 Bryhawke Circle, Suite 700
North Charleston, SC 29418
USA

Tel. +1-843 / 225 50 15
Fax +1-843 / 225 50 20

info@gedorettools.com
www.gedorettools.com

GEDORE Tool Trading (Shanghai) Co., Ltd.

1/F, Block 2
1358 Pingan Road,
Minhang, Shanghai
CHINA 201109

Tel. +86-21-3388 7258
Fax +86-21-3388 7259
Service Hotline: 400 880 1858

info@gedore.cn
www.gedore.cn

Ferramentas GEDORE do Brasil S.A.

Rua Vicentina Maria Fidélis, 275 Bairro
Vicentina | Vicentina
São Leopoldo - RS | 93025-340
BRAZIL

Tel. +55 51-35 89 9200
Fax + 55 51-35 89 9222

export@gedore.com.br
www.gedore.com.br

GEDORE Tools S.A. (Pty) Ltd.

103 Qashana Khuzwayo (Shepstone) Road,
New Germany, 3610 - SOUTH AFRICA
PO Box 68, New Germany, 3620
SOUTH AFRICA

Tel. +27 (0) 31 / 705 3587
Fax +27 (0) 31 / 705 3277

general@gedoresa.co.za
www.gedore.co.za

GEDORE (INDIA) Private Limited

148, Sector 3, IMT Manesar
Gurgaon – 122051
Haryana
INDIA

Tel. +91 (0) 124 22910 – 65/66/67
Fax +91 124 2341067

sales@gedoreindia.com
www.gedore.in

GEDORE TOOLS MIDDLE EAST FZE

PO Box 372042
West Wing 5B
Office# 440
Dubai Airport Free Zone
Dubai - U.A.E

Tel. +971 4 236 4606

info@gedore.ae

GEDORE TOOL CENTER OOO

4-ya Magistralnaja H11/1
123007 Moscow
RUSSIA

Tel. 8 800 100 58 96 (free from Russia)
Tel. +7 (499) 754 7000
Fax +7 (8) 985 22 99 88 0

sales@gedorettools.ru

DISCLAIMER

This catalogue replaces all previous editions. The photographs and technical details are of the articles at present offered.

Since we are constantly updating and improving our products to keep them at the present state of the art, we reserve the right to make modifications and changes with regard to appearance, dimensions (always in "mm", if not otherwise stated), weights and properties, as well as in performance. No claim for correction or replacement supplies may thus be made with regard to products already delivered. Cancellations may be made at any time without there being any grounds for legal claim.

All information on use or safety is non-binding; nor does it replace any legal regulations or those made by professional or trade associations.

We do not accept any liability for printing errors. No supplemental items (tools etc.) are included in the scope of supply. Reprinting, even of excerpts, requires the previous permission in writing by GEDORE. All rights reserved worldwide.

We refer to our current general agreements and commercial conditions as well as our delivery and payment conditions in the imprint under www.gedore.com

GEDORE-Werkzeugfabrik GmbH & Co. KG
Remscheider Straße 149, 42899 Remscheid
Postfach 120361, 42873 Remscheid

Overall concept, design and layout:
GEDORE-Werkzeugfabrik GmbH & Co. KG,
Remscheid in cooperation with
BAGO DIWA, Düsseldorf

© Copyright by GEDORE , Germany



Brands of the GEDORE Group
gedore.com · ochsenkopf.com

YOUR DEALER